

1 Installation and Startup Guide

This document covers the installation of cMT3108XP (W) Series HMI, for the detailed specifications and operation, please refer to Datasheet, Brochure, and User Manual. Please read all warnings, precautions, and instructions on the device carefully before use.

Install Environment:

NEMA Rating	The HMI product is NEMA 4 rated (indoor use only).
Electrical Environment	The HMI product has been tested to conform to European CE requirements. This means that the circuitry is designed to resist the effects of electrical noise. This does not guarantee noise immunity in severe cases. Proper wire routing and grounding will insure proper operation.
Environmental Considerations	<ol style="list-style-type: none"> (1) Make sure that the displays are installed correctly and that the operating limits are followed. Avoid installing units in environments where severe mechanical vibration or shocks are present. (2) The HMI product is certified in accordance with ATEX zone 2/22 categories 3 G/D. The unit has to be installed in an additional enclosure ensuring a minimal protection level for 3G/D equipment. The enclosure equipped with the unit has to be certified and shouldn't be opened when an explosive atmosphere is present. (3) Do not install the unit where acid gas, such as SO₂ exists. (4) This device should be mounted in the vertical position and for use on the flat surface enclosure. (5) For use in Pollution Degree 2 Environment and dry location. (6) Relative Humidity: 10% ~ 90% (non-condensing)
Operating Altitude (Atmospheric Pressure)	Below 3,000 m (9842.52 ft.), atmospheric pressure is 70.1 kPa.
IP Rating	IP 66
Cleaning Considerations	Clean the device using dry cloths. Do not use liquid or spray detergents for cleaning.
Warning	Protection impairment if used in a manner not specified by the manufacturer. Déficit de protection si utilisé d'une manière non spécifiée par le fabricant.

2 Unpacking the Unit

Unpack and check the delivery. If damage is found, please contact the supplier.

NOTE: Place the operator panel on a stable surface during installation. Dropping it or letting it fall may cause damage.

The package includes:

- (1) Installation Instruction, 2-sided A4 *1
- (2) Human Machine Interface *1
- (3) Power Connector *1
- (4) Brackets & Screws *1 pack
- (5) USB Stick Clamp & Tying Strap *1

3 Installation Instructions

Use a control box that provides enough stiffness. Cutout Dimension: 255 mm x 185 mm. Secure the operator panel in position, using all the fastening holes and the provided brackets and screws. Screw Torque: 2.6 ~ 3.9 lbf.in. (For reaching waterproof effect and preventing the panel from being

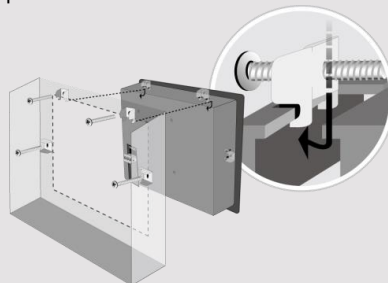

deformed.)

Plan for adequate space around the unit and inside the enclosure, for ventilation and cables. Consider the heat from other devices inside the enclosure. The ambient temperature around the unit must be 0 ~ 55°C

Minimum required clearances (along the overlay): Top 15 mm / Bottom 50 mm / Sides 80 mm
Maximum panel thickness: 4 mm

USB Stick Clamp Usage

Combining the USB Stick with the clamp and the tying strap can prevent USB stick from disconnecting with HMI when strong vibration is present.

1. Insert the USB connector to the clamp and tie them together with the tying strap.
2. Press the spring and insert the USB stick into HMI.

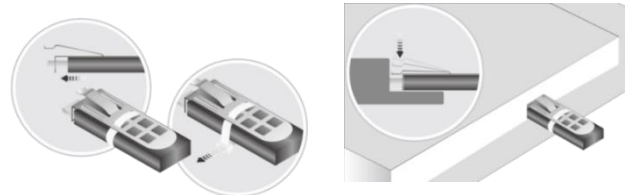

Expansion Module and Magnetic Mount Antenna

1. Connect the expansion module by inserting it into the given slot in HMI's rear cover.
2. Tighten the module to HMI's rear cover using two M3*8L screws.
3. Lock the antenna's SMA connector to the module's connector.

Please reserve space for installing the antenna with minimum bend radius taken into consideration, in order to prevent physical damage to the antenna or impairment of the antenna's performance.

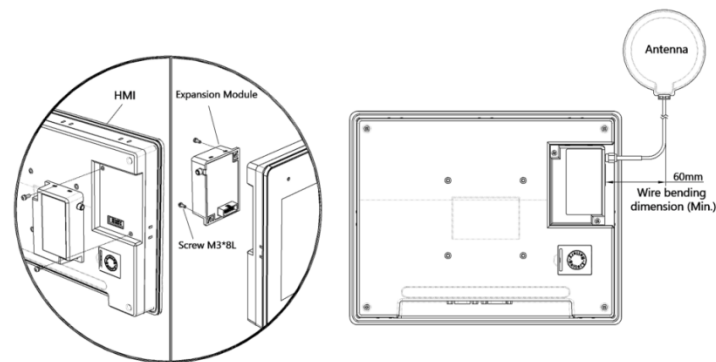

4 Power Connections

Power Connector Specifications:
Wire AWG: 24~12
Wiring Conductor Minimum Temperature: 75°C
Screw Torque: 4.5 lbf-in (max.)
Copper conduct only.

Spécifications du connecteur d'alimentation:
AWG de fil: 24 ~ 12
Température minimale du conducteur de câblage: 75°C
Couple de vis: 4.5 lbf-in (max.)
Conducteur en cuivre seulement

NOTE: Connect positive DC line to the '+' terminal and the DC ground to the '-' terminal.

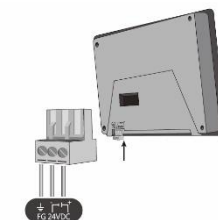

5 System Settings

After powering on the HMI, a countdown screen will be displayed. If no action is taken within the countdown period, the screen redirects to the designated Default Website.

Click the [System Settings] button and enter the system password (default: 111111) to access the system settings menu. Here, configure the Web Browser, Network, change the system password, and adjust other settings.

Change Default Website

The built-in browser will browse to the default website after seconds defined in [Countdown before Start] setting. To change the default website and countdown time, open the [Web Browser Setting] tab.

Increase countdown time if the web server starts slower than the browser.

Change Password

To change the system password, open the [Administration] tab. Enter the current password, then the new password, and confirm the new password to complete the update.

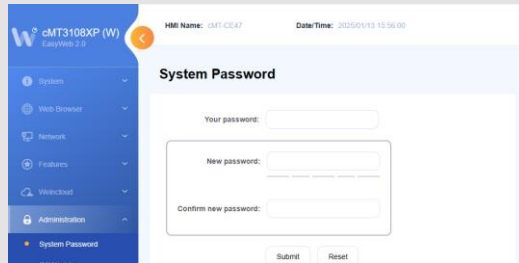
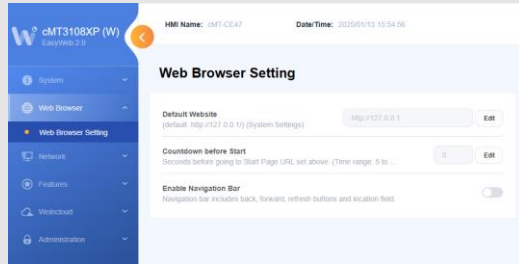
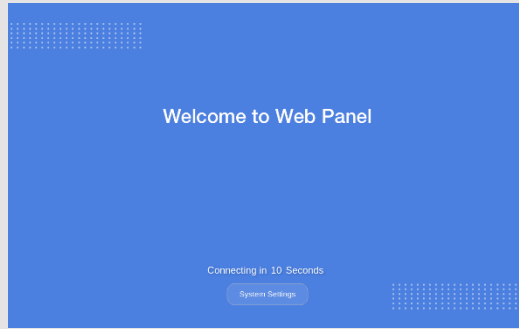

6 Restore Factory Default

To restore factory default, follow section 5 instructions of this manual to open the setting page, and then enter "default111111", and press [Reset]. Please note that all browser and system settings (including network and passwords) will be reset to factory default.

7 Battery Replacement

Battery Specification: Type CR2032, Rated 3V

Battery replacement shall be performed by qualified personnel (engineer) only and care must be taken when handling lithium batteries. For more information on battery replacement and disposal considerations, please refer to the following link:

http://www.weintek.com/download/MT8000/eng/FAQ/FAQ_103_Replace_Battery_en.pdf

CAUTION



Power

NOTE: Make sure that all local and national electrical standards are met when installing the unit. Contact your local authorities to determine which codes apply.

Use power output that meets SELV (Safety Extra-Low Voltage) requirements. The unit can be powered by DC power only, voltage range: 24±20%, compatible with most controller DC systems. The power conditioning circuitry inside the unit is accomplished by a switching power supply. The peak starting current can be as high as 2A.



Fusing Requirements

If the display does not come on within 5 seconds of power up, remove power. A resettable fuse will protect against overcurrent faults in DC circuit and the resetting will take place after a period of time. Check wiring for proper connections and try to power up again.



High Voltage

A resettable fuse will prevent damage for overcurrent condition however it isn't guaranteed. DC voltage sources should provide proper isolation from main AC power and similar hazards.



Emergency Stop

A Hard-wired EMERGENCY STOP should be fitted in any system using an HMI to comply with ICS Safety Recommendations.



Supply Voltage Condition

Do not power the unit and inductive DC loads, or input circuitry to the controller, with the same power supply. Note: The 24 VDC output from some controllers may not have enough current to power the unit.



Wire Routing

- Power wire length should be minimized (Max: 500m shielded, 300m unshielded).
- Please use twisted pair cables for power wire and signal wire and conform to the impedance matching.
- If wiring is to be exposed to lightning or surges, use appropriate surge suppression devices.
- Keep AC, high energy, and rapidly switching DC power wiring separated from signal wires.
- Add a resistor and capacitor in the parallel connection between the ungrounded DC power supply and the frame ground. This provides a path for static and high frequency dissipation. Typical values to use are 1M Ohm and 4700pF.

DANGER



Hardware Considerations

The system designer should be aware that devices in Controller systems could fail and thereby create an unsafe condition. Furthermore, electrical interference in an operator interface can lead to equipment start-up, which could result in property damage and/or physical injury to the operator.

If you use any programmable control systems that require an operator, be aware that this potential safety hazard exists and take appropriate precautions. Although the specific design steps depend on your particular application, the following precautions generally apply to installation of solid-state programmable control devices, and conform to the guidelines for installation of Controllers recommended in NEMA ICS 3-304 Control Standards.



Programming Considerations

To conform to ICS Safety Recommendations, checks should be placed in the controller to ensure that all writable registers that control critical parts of plant or machinery have limit checks built into the program, with an out-of-limit safe shut down procedure to ensure safety of personnel.

GMEC3A8P1_cMT3108XP (W)_Installation_20241218

Limited Warranty

This product is limited warranted against defects in design and manufacture. The proven defective product will either be repaired or replaced, at Weintek's discretion. This warranty shall not cover any product which is

- Out of warranty period which is 12 months from the manufacturing month of the HMI products.
- Damage caused by Force Majeure, accident, negligence, improper installation or misuse.
- Product has been repaired or taken apart by unauthorized technicians.
- Products whose identification markings have been removed or damaged.