

1 Installation and Startup Guide

This document covers the installation of cMT-G04 Series HMI, for the detailed specifications and operation, please refer to Datasheet, Brochure and EasyBuilder Pro User Manual. Please read all warnings, precautions, and instructions on the device carefully before use.

Install Environment:

Electrical Environment	The HMI product has been tested to conform to European CE requirements. This means that the circuitry is designed to resist the effects of electrical noise. This does not guarantee noise immunity in severe cases. Proper wire routing and grounding will insure proper operation.
Environmental Considerations	<ol style="list-style-type: none"> (1) Make sure that the units are installed correctly and that the operating limits are followed. Avoid installing units in environments where severe mechanical vibration or shocks are present. (2) Do not operate the unit in areas subject to explosion hazards due to flammable gases, vapors or dusts. (3) Do not install the unit where acid gas, such as SO2 exists. (4) This device should be mounted in the vertical position and for use on the flat surface enclosure. (5) For use in Pollution Degree 2 Environment and dry location. (6) Relative Humidity: 10% ~ 90% (non-condensing)
Operating Altitude (Atmospheric Pressure)	Below 3,000 m (9842.52 ft.), atmospheric pressure is 70.1 kPa.
IP rating	IP 20
Cleaning Considerations	Clean the device using dry cloths. Do not use liquid or spray detergents for cleaning.
Warning	Protection impairment if used in a manner not specified by the manufacturer. Déficit de protection si utilisé d'une manière non spécifiée par le fabricant.

2 Unpacking the Unit

Unpack and check the delivery. If damage is found, please contact the supplier.

NOTE: Place the operator panel on a stable surface during installation. Dropping it or letting it fall may cause damage.

The package includes:

- (1) Installation Instruction, 2-sided A4 *1
- (2) cMT-G04 *1
- (3) Power Connector *1

3 Installation Instructions

Rail mounting: DIN rail 35mm

Panel mounting: Use two M4 or #8 panhead screws, mounting hole size is 4.6mm

Plan for adequate space around the unit and inside the enclosure, for ventilation and cables. Consider the heat from other devices inside the enclosure. The ambient temperature around the unit must be 0 ~ 50°C.

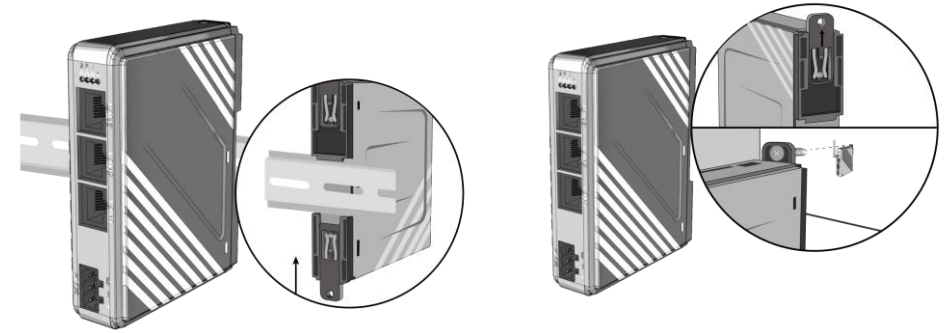

4 Power Connections

Power Connector Specifications:
 Wire AWG: 24~12
 Wiring Conductor Minimum Temperature: 75°C
 Screw Torque: 4.5 lbf-in (max.)
 Copper conduct only.



Spécifications du connecteur d'alimentation:
 AWG de fil: 24 ~ 12
 Température minimale du conducteur de câblage: 75°C
 Couple de vis: 4.5 lbf-in (max.)
 Conducteur en cuivre seulement

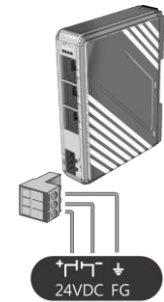

NOTE:

1. Connect positive DC line to the '+' terminal and the DC ground to the '-' terminal.

5 System Settings

Connect SW1 and SW2 to machine network and LAN port to company/factory network.

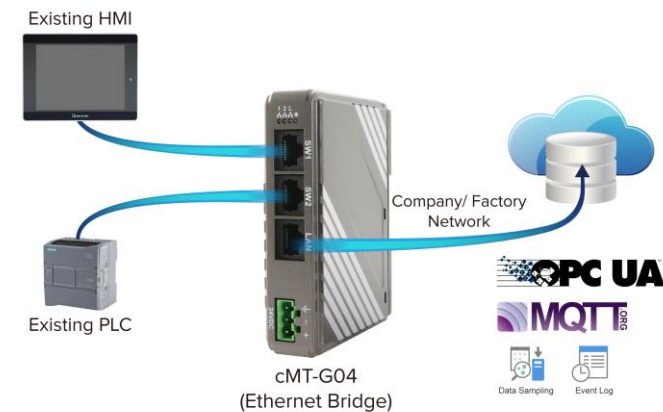

cMT-G04 can be configured by the following ways.
 Way1. Connect cMT-G04's LAN port with a PC, and on the PC open a web browser and then enter: <http://169.254.0.1>, password: 111111.

Way2. Find cMT-G04 IP in Utility Manager, and then use web browser on PC to log in.

The page opened can be used to download /upload project files, change network IP or password, and more.

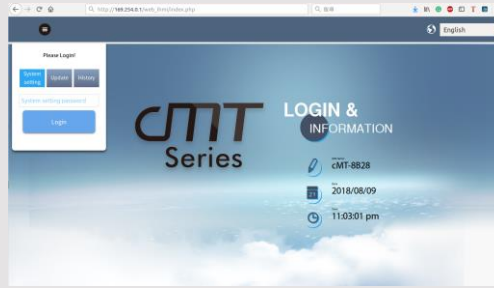

6 EasyBuilder Pro Software Settings

Launch EasyBuilder Pro software, select your project file, press F7 shortcut key to open the download dialog box: Select Ethernet > IP tab > Enter your HMI IP > Click Download to download this project file to HMI. (Please refer to EasyBuilder Pro User Manual for software operation details)

7 SW1 SW2

SW1 to SW2 are connected via an internal Ethernet switch.

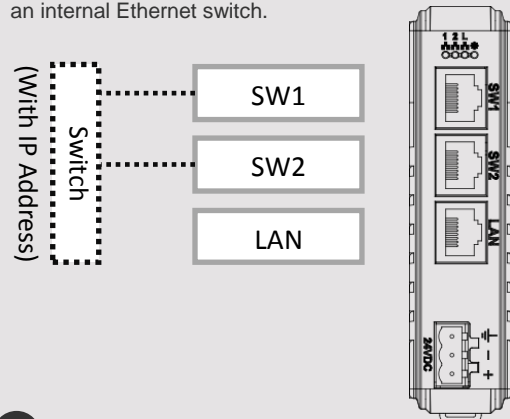

8 Restore Factory Default

Press and hold on the Default button on the unit for more than 15 seconds to restore factory default. The IP setting will be restored to default:
 SW1 SW2: 192.168.100.1
 LAN: DHCP
 Please note that the projects and data stored in the unit are all cleared after pressing this button.

9 Battery Replacement

Battery Specification: UL Certification Battery, Type CR1220, Rated 3V, Max. Abnormal Charging Current 10mA, Working Temperature: max. 70°C

Battery replacement shall be performed by qualified personnel (engineer) only and care must be taken when handling lithium batteries. For more information on battery replacement and disposal considerations, please refer to the following link:

http://www.weintek.com/download/MT8000/eng/FAQ/FAQ_103_Replace_Battery_en.pdf

CAUTION

NOTE: Make sure that all local and national electrical standards are met when installing the unit. Contact your local authorities to determine which codes apply.



Power

Use power output that meets SELV (Safety Extra-Low Voltage) requirements. The unit can be powered by DC power only, voltage range: 10.5~28VDC, compatible with most controller DC systems. The power conditioning circuitry inside the unit is accomplished by a switching power supply. The peak starting current can be as high as 500mA.



Fusing Requirements

If the Power LED does not light up immediately after power up, remove power. A resettable fuse will protect against overcurrent faults in DC circuit and the resetting will take place after a period of time. Check wiring for proper connections and try to power up again.



High Voltage

A resettable fuse will prevent damage for overcurrent condition however it isn't guaranteed. DC voltage sources should provide proper isolation from main AC power and similar hazards.



Emergency Stop

A Hard-wired EMERGENCY STOP should be fitted in any system using an HMI to comply with ICS Safety Recommendations.

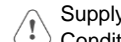

Supply Voltage Condition

Do not power the unit and inductive DC loads, or input circuitry to the controller, with the same power supply. Note: The 12 or 24 VDC output from some controllers may not have enough current to power the unit.

- Power wire length should be minimized (Max: 500m shielded, 300m unshielded).
- Please use twisted pair cables for power wire and signal wire and conform to the impedance matching.
- If wiring is to be exposed to lightning or surges, use appropriate surge suppression devices.
- Keep AC, high energy, and rapidly switching DC power wiring separated from signal wires.
- Add a resistor and capacitor in the parallel connection between the ungrounded DC power supply and the frame ground. This provides a path for static and high frequency dissipation. Typical values to use are 1M Ohm and 4700pF.



Wire Routing

DANGER

The system designer should be aware that devices in Controller systems could fail and thereby create an unsafe condition. Furthermore, electrical interference in an operator interface can lead to equipment start-up, which could result in property damage and/or physical injury to the operator.



Hardware Considerations

If you use any programmable control systems that require an operator, be aware that this potential safety hazard exists and take appropriate precautions. Although the specific design steps depend on your particular application, the following precautions generally apply to installation of solid-state programmable control devices, and conform to the guidelines for installation of Controllers recommended in NEMA ICS 3-304 Control Standards.

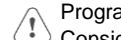

Programming Considerations

To conform to ICS Safety Recommendations, checks should be placed in the controller to ensure that all writable registers that control critical parts of plant or machinery have limit checks built into the program, with an out-of-limit safe shut down procedure to ensure safety of personnel.

GMECMG400_cMT-G04_Installation_20240627

Limited Warranty

This product is limited warranted against defects in design and manufacture. The proven defective product will either be repaired or replaced, at Weintek's discretion. This warranty shall not cover any product which is

- Out of warranty period which is 12 months from the manufacturing month of the HMI products.
- Damage caused by Force Majeure, accident, negligence, improper installation or misuse.
- Product has been repaired or taken apart by unauthorized technicians.
- Products whose identification markings have been removed or damaged.