



# APC-3x97B User Manual

(SBC-7106A)

Fanless Total IP65 Intel Atom D2550

Stainless Steel Panel PC

**Release Date**

**Revision**

Oct. 2014

V1.0

©2014 Aplex Technology, Inc.

All Rights Reserved.

Published in Taiwan

**Aplex Technology, Inc.**

15F-1, No.186, Jian Yi Road, Zhonghe District, New Taipei City 235, Taiwan

Tel: 886-2-82262881 Fax: 886-2-82262883 E-mail: [aplex@aplex.com.tw](mailto:aplex@aplex.com.tw) URL: [www.aplex.com.tw](http://www.aplex.com.tw)

# Warning!

---

This equipment generates, uses and can radiate radio frequency energy and if not installed and used in accordance with the instructions manual, it may cause interference to radio communications. It has been tested and found to comply with the limits for a Class A computing device pursuant to FCC Rules, which are designed to provide reasonable protection against such interference when operated in a commercial environment. Operation of this equipment in a residential area is likely to cause interference in which case the user at his own expense will be required to take whatever measures may be required to correct the interference.

Electric Shock Hazard – Do not operate the machine with its back cover removed. There are dangerous high voltages inside.

# Packing List

Accessories (as ticked) included in this package are:

- Power Connector
- Driver & manual CD disc
- Other. \_\_\_\_\_ (please specify)

## Safety Precautions

Follow the messages below to prevent your systems from damage:

- ◆ Avoid your system from static electricity on all occasions.
- ◆ Prevent electric shock. Don't touch any components of this card when the card is power-on. Always disconnect power when the system is not in use.
- ◆ Disconnect power when you change any hardware devices. For instance, when you connect a jumper or install any cards, a surge of power may damage the electronic components or the whole system.

# Table of Contents

---

Warning!.....	2
Packing List.....	3
Safety Precautions.....	3

## **Chapter 1** **Getting Started**

---

1.1 Features.....	6
1.2 Specifications.....	6
1.3 Dimensions.....	8
1.4 Brief Description of APC-3x97B.....	9

## **Chapter 2** **Hardware**

---

2.1 Mainboard Introduction.....	10
2.2 Specifications.....	10
2.3 Jumpers and Connectors Location.....	13
2.4 Jumpers Setting and Connectors.....	14

## **Chapter 3** **BIOS Setup**

---

3.1 Operations after POST Screen.....	39
3.2 BIOS Setup Utility.....	39
3.3 Main Settings.....	40
3.4 Advanced Settings.....	41
3.5 Chipset Settings.....	47
3.6 Boot Settings.....	50
3.7 Security Settings.....	52
3.8 Save and Exit Settings.....	53

## **Chapter 4** **Installation of Drivers**

---

4.1 Intel Chipset Driver.....	56
4.2 Intel Graphics Media Accelerator Driver.....	59
4.3 Intel (R) Network Adapter.....	62
4.4 Realtek ALC662 HD Audio Driver Installation.....	65

5.1 Windows 2000/2003/Vista/WIN7 Universal Driver Installation for PenMount 6000 Series.....	67
5.2 Software Functions.....	71

## Figures

Figure 1.1: Dimensions of APC-3797B.....	8
Figure 1.2: Dimensions of APC-3997B.....	8
Figure 1.3: Front View of APC-3X97B.....	9
Figure 1.4: Rear View of APC-3X97B.....	9
Figure 2.1: Mainboard Dimensions.....	12
Figure 2.2: Jumpers and Connectors Location_ Board Top.....	13
Figure 2.3: Jumpers and Connectors Location_ Board Bottom.....	13

## 1.1 Features

- Fanless Design
- Intel® Atom™ Processor D2550
- Onboard 4GB DDR3
- 11~32V DC wide-ranging power input
- Total 6 sides IP 65
- 5-Wire Resistive Touch Screen

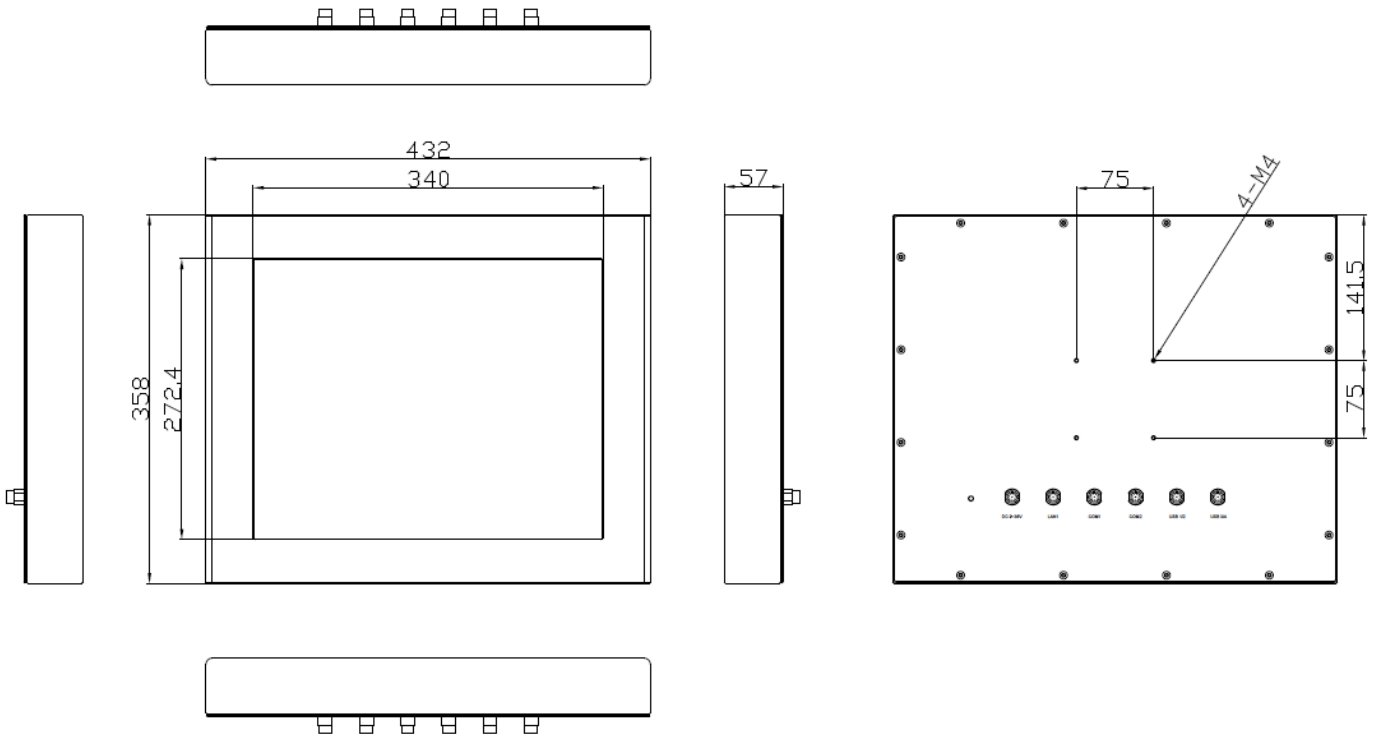
## 1.2 Specifications

	APC-3797B	APC-3997B
<b>System</b>		
CPU	Intel® Atom Processor D2550 (1M Cache, 1.8 GHz)	
System Chipset	Intel NM10 Express	
System Memory	Onboard 4GB DDR3	
Motherboard	SBC-7106A-D2550 4G	
<b>IO Port</b>		
USB	1 x M12 8pin for 2 x USB 1 x M12 8pin for 2 x USB	
Serial/Parallel	1 x M12 8pin for COM 1/RS-232/422/485 (Default RS-232) 1 x M12 8pin for COM 2/RS-232	
Audio	None	
Graph	None	
LAN	1 x M12 8pin for LAN 1	
Digital I/O	None	
KB/MS	None	
Membrane control	None	
Power	1 x M12 3pin DC power connector	
<b>Storage Space</b>		
HDD	1 x 2.5" HDD space	
Movable device	1 x Internal SD slot	
<b>Expansion Slot</b>	1 x Mini PCIe half size Option WLAN/BT Module and Antenna	
<b>Display</b>		

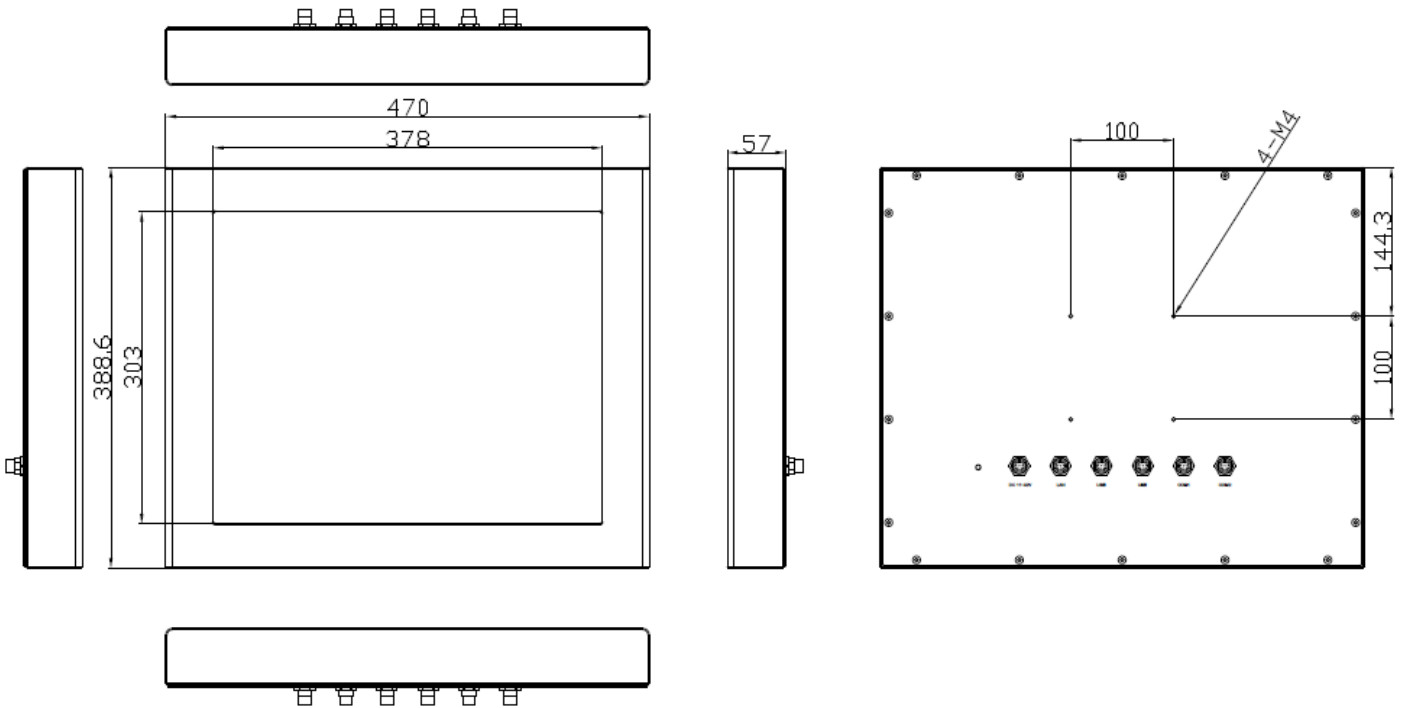
Display Type	17" Color TFT LCD	19" Color TFT LCD
Max. Resolution	1280x1024	1280x1024
Max. Color	16.7M	16.7M
Luminance (cd/m <sup>2</sup> )	350	350
View angle(H°/V°)	170/170	170/160
Contrast Ratio	1000:1	1000:1
Backlight lifetime(hrs)	50000	
<b>Touch screen</b>		
Type	Resistive Type	
Interface	USB	
Light Transmission(%)	80%	
<b>Power</b>		
Power Input	11~32V DC	
<b>Mechanical</b>		
Construction	Stainless steel	
IP Rating	Total IP65	
Mounting	VESA 75 x 75	VESA 100 x 100
Dimension (mm)	432 x 358 x 57	470 x 388.6 x 57
Net Weight (Kgs)	9.8	11.2
<b>Environmental</b>		
Operating temperature(°C)	0°C to 50°C (with HDD) -20~60 (with Industrial storage)	
Storage temperature(°C)	-20~60°C	
Storage humidity	10 to 90% @ 40°C, non- condensing	
Certification	CE / FCC Class A	
<b>Operating System Support</b>	Microsoft Windows 7 pro for embedded, Windows embedded standard 7	

**Note 1:** It is covered by one or more of the following patents: US6, 570, 884, US6,115,776, and US6,327,625.

# 1.3 Dimensions



**Figure 1.1: Dimensions of APC-3797B**



**Figure 1.2: Dimensions of APC-3997B**



## 1.4 Brief Description of APC-3x97B

APC-3X97B series comes with IP65 certified and is powered by Intel Atom D2550 to provide low power consumption. The stainless steel chassis design makes it exceptionally suitable for strict hygiene regulations for food/chemical industry, medical, restaurant/kitchen applications, storage management and outdoor /information segment and so on. APC-3X97B series has LCD size in 17" and 19" for selections. APC-3X97B supports 5 wires resistive touch. However, GFG type and capacitive touch screen are available for orders as well. Regarding the storage capability, APC-3X97B series provides 1 x 2.5" SATA HDD, 1 x internal SD Slot, and 1x internal mini-PCIe, allowing customers to easily access/backup the data.



**Figure 1.3: Front View of APC-3x97B**



**Figure 1.4: Rear View of APC-3x97B**

## 2.1 Mainboard Introduction

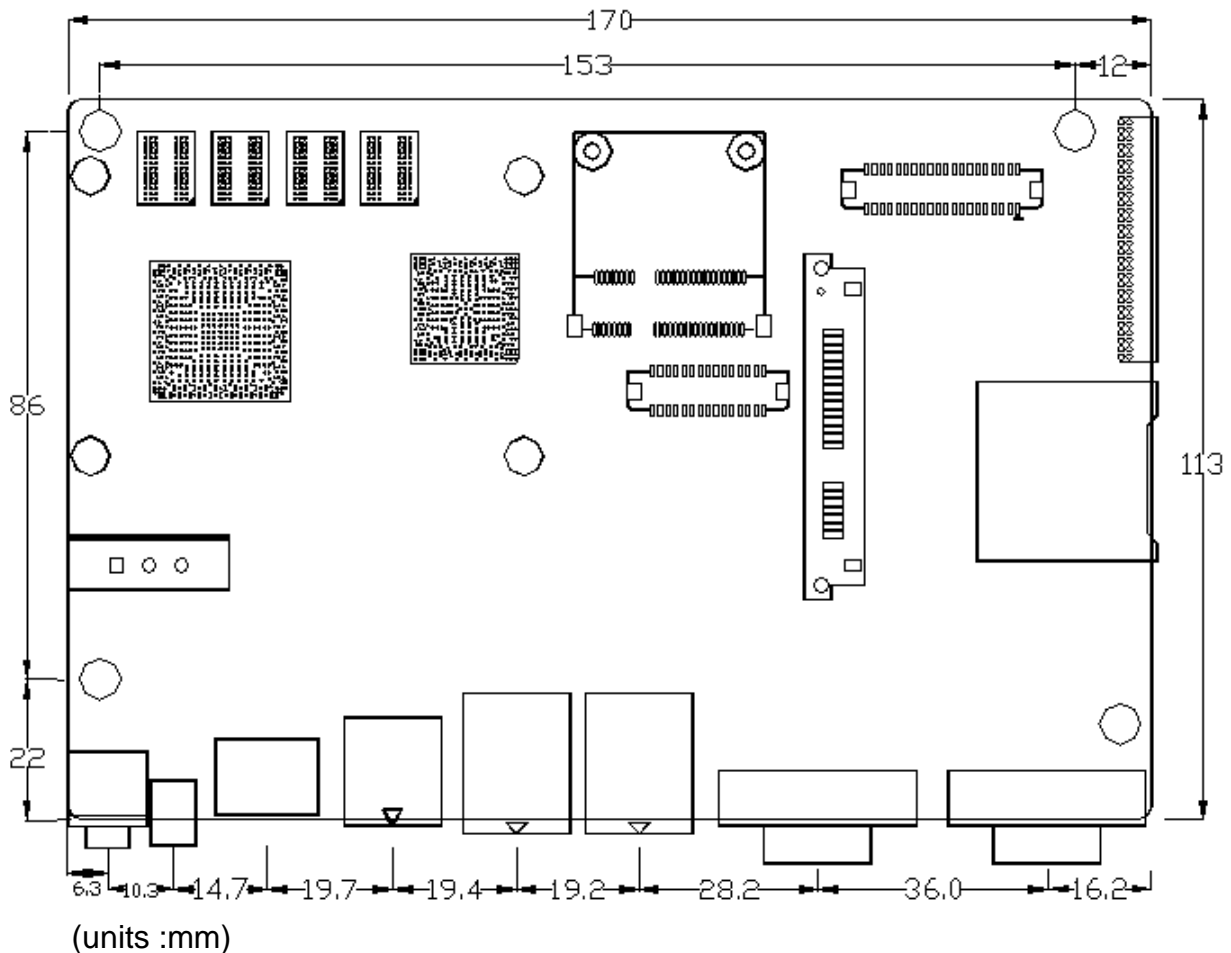
SBC-7106A is a 4" industrial motherboard developed on the basis of Intel Cedarview-M/D Processors and NM10, which provides abundant peripheral interfaces to meet the needs of different customers. Also, it features dual GbE ports, 3-COM ports and one Mini PCIE configuration, one VGA port, one HDMI port, one LVDS interface. To satisfy the special needs of high-end customers, CN1 and CN2 and CN3 richer extension functions. The product is widely used in various sectors of industrial control.

## 2.2 Specifications

Specifications	
<b>Board Size</b>	170mm x 113mm
<b>CPU Support</b>	Intel Atom D2550 /1.86GHz (2cores,10W, onboard) Intel Atom N2600 /1.60GHz (2cores,3.5W, option )
<b>Chipset</b>	Intel NM10 Express
<b>Memory Support</b>	<a href="#">Onboard 4GB DDRIII SDRAM (D2550)</a> Onboard 2GB DDRIII SDRAM (N2600,option)
<b>Graphics</b>	Integrated Intel GMA 3650 (D2550) Integrated Intel GMA 3600 (N2600)
<b>Display Mode</b>	1 x CRT Port 1 x HDMI Port 1 x LVDS (18/24-bit <a href="#">dual</a> LVDS)
<b>Support Resolution</b>	Up to 1920 x 1200 for CRT Up to 1920 x 1200 for HDMI Up to 1920 x 1200 for LVDS (PS8625)
<b>Dual Display</b>	CRT+LVDS CRT+HDMI LVDS+HDMI
<b>Super I/O</b>	Winbond W83627UHG-E
<b>BIOS</b>	AMIBIOS
<b>Storage</b>	1 x SATA Connector (7P) 1 x SATA Connector (7P+15P) 1 x SD Socket (USB to SD)

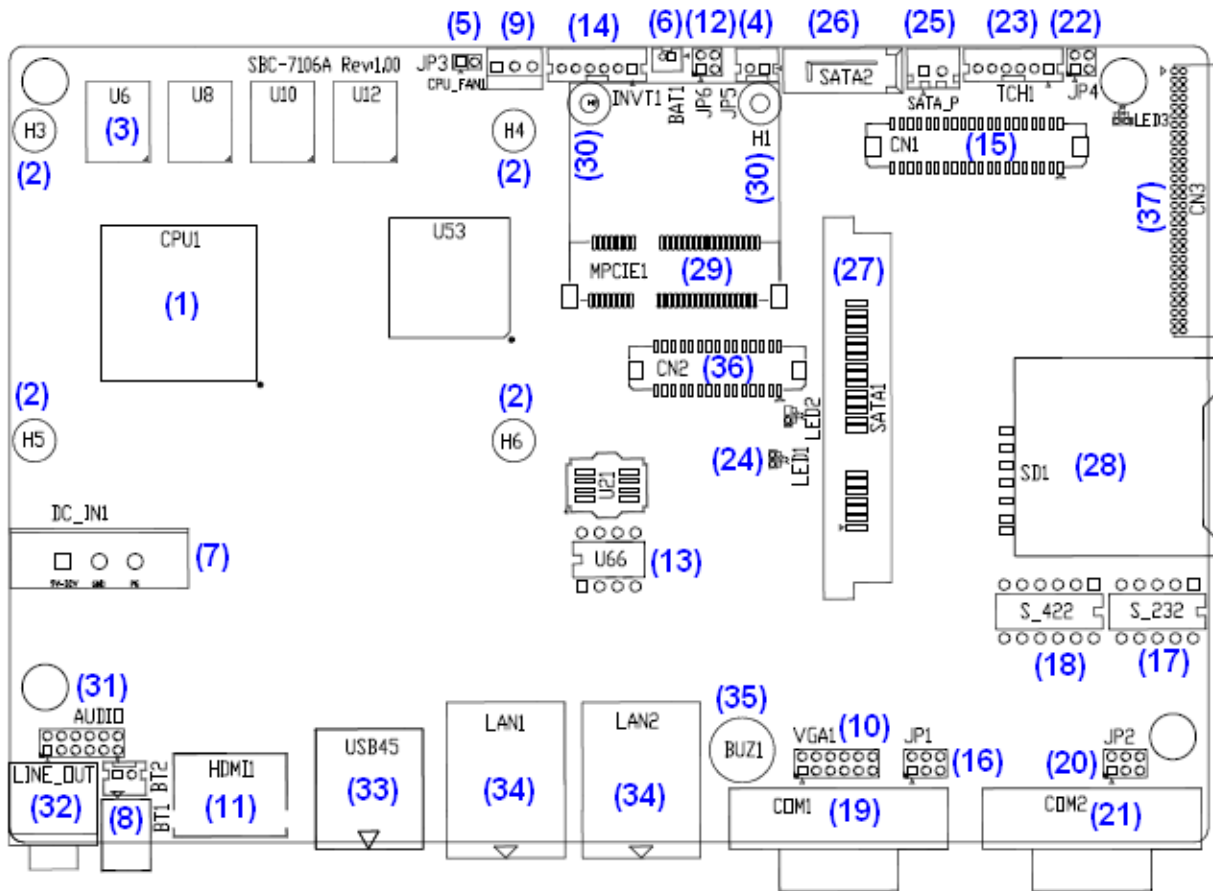
<b>Ethernet</b>	2 x PCIe Gbe LAN by <a href="#">Intel 82574L</a>
<b>USB</b>	2 x USB 2.0 (type A)stack ports (USB4/USB5) 2 x USB 2.0 Pin header for CN3 (USB2/USB3) <a href="#">1 x USB 2.0 Pin header for CN1 (USB0,option)</a> <a href="#">1 x USB 2.0 Pin header for CN2 (USB1)</a> 1 x USB 2.0 for MPCIE1 (USB7)
<b>Serial</b>	1 x RS232/RS422/RS485 port, DB9 connector for external (COM1) pin 9 w/5V/12V/Ring select 1 x RS232 port, DB9 connector for external (COM2) pin 9 w/5V/12V/Ring select 1 x RS422/485 header for CN2 (COM3) 2 x UART for CN3 (COM5,COM6)
<b>Digital I/O</b>	8-bit digital I/O by Pin header (CN2) 4-bit digital Input 4-bit digital Output 4-bit digital I/O by Pin header (CN3) 2-bit digital Input 2-bit digital Output
<b>Battery</b>	Support CR2477 Li battery by 2-pin header
<b>Audio</b>	Support Audio via Realtek ALC662 HD audio codec Support Line-in, Line-out, MIC by 2x6-pin header
<b>Keyboard /Mouse</b>	1 x PS2 keyboard/mouse by 1x6 box pin header (CN3)
<b>Expansion Bus</b>	1 x mini-PCI-express slot 1 x PCI-express (CN3)
<b>Touch Ctrl</b>	1 x Touch ctrl header for TCH1 (COM4)
<b>Power Management</b>	Wide Range DC9V~36V input 1 x 3-pin power input connector
<b>Switches and LED Indicators</b>	1 x Power on/off switch (BT1/BT2/CN2/CN3) 1 x Reset (CN2) 1 x Power LED status (CN1) 1 x HDD LED status (CN2) 1 x Buzzer
<b>External I/O port</b>	2 x COM Ports (COM1/COM2) 2 x USB 2.0 Ports (stack) 2 x RJ45 GbE LAN Ports 1 x HDMI Port

	1 x Stack audio Jack (Line out)
<b>Watchdog Timer</b>	Software programmable 1 – 255 second by Super I/O
<b>Temperature</b>	Operating: -20°C to 70°C Storage: -40°C to 85°C
<b>Humidity</b>	5% - 95%, non-condensing, operating
<b>Power Consumption</b>	12V /0.95A (Intel Atom N2600 processor with 2GB DDR3 DRAM)
<b>EMI/EMS</b>	Meet CE/FCC class A
<b>TB-528CAN2</b>	2 x CAN bus
	1 x SIM Card Socket
	1 x mini-PCI-express slot

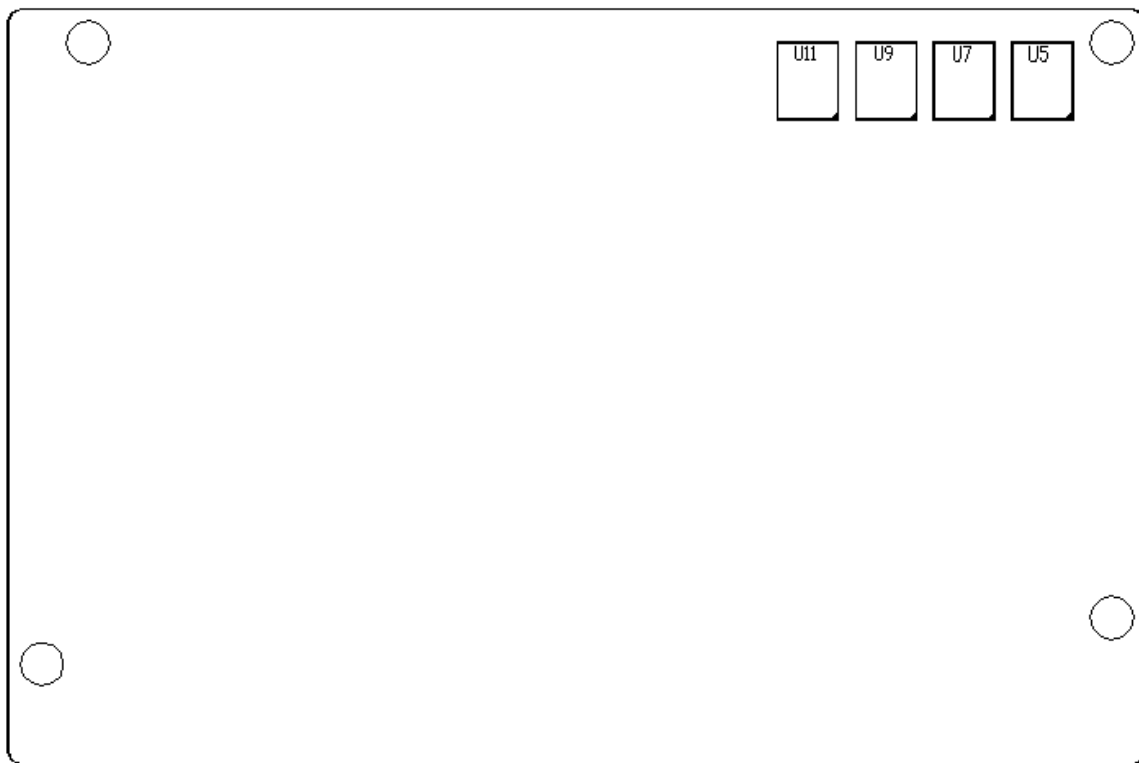


**Figure 2.1: Mainboard Dimensions**

## 2.3 Jumpers and Connectors Location



**Figure 2.2: Jumpers and Connectors Location- Board Top**



**Figure 2.3: Jumpers and Connectors Location- Board Bottom**

## 2.4 Jumpers Setting and Connectors

### 1. CPU1:

(FCBGA559), onboard Intel Intel Cedarview-M/D Processors

Model	CPU
SBC-7106A-D25-4G	D2550
SBC-7106A-D25P-4G	D2550 ( option )
SBC-7106A-N26-2G	N2600 ( option )

### 2. H3/H4/H5/H6:

CPU1 and U53\_Heat Sink Screw holes, four screw holes for intel D2550 (or N2600) and NM10 Heat Sink assemble.

### 3. U5/U6/U7/U8/U9/U10/U11/U12:

Onboard DDRIII Memory

Model	Memory
SBC-7106A-D25-4G	4GB
SBC-7106A-D25P-4G	4GB ( option )
SBC-7106A-N26-2G	2GB ( option )

### 4. JP5:

(2.0mm Pitch 1x2 box Pin Header), ATX Power and Auto Power on jumper setting.

JP5	Mode
Open	ATX Power
Close	Auto Power on (option)

S-422	Mode
Pin11-12 ( Off )	ATX Power
Pin11-12 ( On )	<b>Auto Power on (Default)</b>

### 5. JP3:

(2.0mm Pitch 1x2 Pin Header) CMOS clear jumper, CMOS clear operation will permanently reset old BIOS settings to factory defaults.

JP3	CMOS
Open	Normal (Default)
Close 1-2	Clear CMOS



### Procedures of CMOS clear:

- a) Turn off the system and unplug the power cord from the power outlet.
- b) To clear the CMOS settings, use the jumper cap to close pins 1 and 2 for about 3 seconds then reinstall the jumper clip back to pins open.
- c) Power on the system again.
- d) When entering the POST screen, press the <F1> or <DEL> key to enter CMOS Setup Utility to load optimal defaults.
- e) After the above operations, save changes and exit BIOS Setup.

Model	JP3
SBC-7106A-N26	No
SBC-7106A-D25	Yes
SBC-7106A-D25P	Yes

### 6. BAT1:

(1.25mm Pitch 1x2 box Pin Header) 3.0V Li battery is embedded to provide power for CMOS.

Pin#	Signal Name
Pin1	VBAT
PIN2	Ground

### 7. DC\_IN1:

(5.08mm Pitch 1x3 Pin Connector),DC9V~32V System power input connector.

Pin#	Power Input
Pin1	DC+9V~32V
Pin2	Ground
Pin3	FG

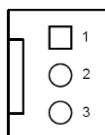
Model	DC_IN1
SBC-7106A-D25	180°Connector
SBC-7106A-D25P	45°Connector
SBC-7106A-N26	180°Connector

### 8. BT1/BT2:

**Power on/off button**, They are used to connect power switch button. The two pins are disconnected under normal condition. You may short them temporarily to realize system startup & shutdown or awaken the system from sleep state.

## 9. CPU\_FAN1:

(2.54mm Pitch 1x3 Pin Header), Fan connector, cooling fans can be connected directly for use. You may set the rotation condition of cooling fan in menu of BIOS CMOS Setup.



Pin#	Signal Name
1	Ground
2	VCC
3	Rotation detection



### Note:

Output power of cooling fan must be limited under 5W.

Model	CPU_FAN1
SBC-7106A-D25	Yes
SBC-7106A-D25P	Yes
SBC-7106A-N26	No

## 10. VGA1:

(CRT 2.0mm Pitch 2X6 Pin Header), Video Graphic Array Port, Provide 2x6Pin cable to VGA Port.

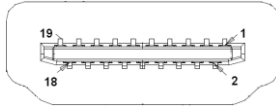
Signal Name	Pin#	Pin#	Signal Name
CRT_RED	1	2	Ground
CRT_GREEN	3	4	Ground
CRT_BLUE	5	6	VGA_EN
CRT_H_SYNC	7	8	CRT_DDCDATA C
CRT_V_SYNC	9	10	CRT_DDCCLK
Ground	11	12	Ground

VGA hot plug setting for Windows XP :	
VGA1 ( Pin Header )	Function
Pin4-Pin6 ( Close )	VGA Simulation Disabled
Pin4-Pin6 ( Open )	VGA Simulation Enabled
use the 2.0mm jumper cap to close pin 4 and pin6	

## 11. HDMI1:

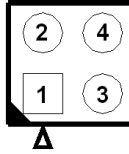
(HDMI 19P Connector), High Definition Multimedia Interface connector.





**12. JP6:**

(2.0mm Pitch 2x2 Pin Header), LVDS jumper setting.



JP6	Function (CN1)
Pin1-Pin2 ( Close )	Single channel LVDS
<b>Pin1-Pin2 ( Open )</b>	<b>Dual channel LVDS (Default)</b>
<b>Pin3-Pin4 ( Close )</b>	<b>8/24 bit (Default)</b>
Pin3-Pin4 ( Open )	6/18 bit

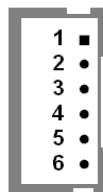
**13. U66:**

AT24C02-DIP8, The EEPROM IC ( U66 ) is the set of LVDS resolution. If you need other resolution settings, please update U66 data.

Model	LVDS resolution
SBC-7106A-D25 SBC-7106A-D25P SBC-7106A-N26	1280*1024 (Default)
	800*480 ( option )
	800*600 ( option )
	1024*768 ( option )
	1920*1080 ( option )
	.....

**14. INVT1:**

(2.0mm Pitch 1x6 wafer Pin Header), Backlight control connector for LVDS.



Pin#	Signal Name
1	+DC12V
2	+DC12V
3	Ground
4	Ground

5	BKLT_EN_OUT
6	BKLT_CTRL



**Note:**

Pin6 is backlight control signal, support DC or PWM mode, mode select at BIOS CMOS menu.

**15. CN1:**

(1.25mm Pitch 2x20 Connector, DF13A-40DP-1.25V), For 18/24-bit LVDS2 output connector, Fully supported by Parad PS8625(DP to LVDS), the interface features dual channel 24-bit output. Low Voltage Differential Signaling, A high speed, low power data transmission standard used for display connections to LCD panels.

Function	Signal Name	Pin#		Signal Name	Function
LVDS	12V_S0	2	1	12V_S0	LVDS
	BKLT_EN_OUT	4	3	BKLT_CTRL	
	Ground	6	5	Ground	
	LVDS_VDD5	8	7	LVDS_VDD5	
	LVDS_VDD3	10	9	LVDS_VDD3	
	Ground	12	11	Ground	
	LA_D0_P	14	13	LA_D0_N	
	LA_D1_P	16	15	LA_D1_N	
	LA_D2_P	18	17	LA_D2_N	
	LA_D3_P	20	19	LA_D3_N	
	LA_CLKP	22	21	LA_CLKN	
	LB_D0_P	24	23	LB_D0_N	
	LB_D1_P	26	25	LB_D1_N	
	LB_D2_P	28	27	LB_D2_N	
	LB_D3_P	30	29	LB_D3_N	
	LB_CLKP	32	31	LB_CLKN	
	Ground	34	33	Ground	USB0 (JP4 open)
USB0 (JP4 open)	USB0_P	36	35	USB0_N	
	5V_S5_USB	38	37	5V_S5_USB	
Power LED	PWR_LED+	40	39	Ground	Power LED

**17. S\_232:**

(Switch),COM1 jumper setting, it provides selectable RS232 or RS422 or RS485 serial signal output.

Function	S_232 Pin#
<b>RS232 (Default)</b>	<b>ON: Pin1, Pin2, Pin3, Pin4</b>
RS422 (option)	OFF: Pin1, Pin2, Pin3, Pin4
RS485 (option)	OFF: Pin1, Pin2, Pin3, Pin4

**18. S\_422:**

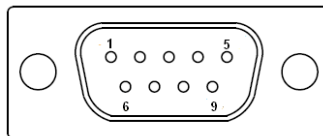
(Switch),COM1 setting, it provides selectable RS232 or RS422 or RS485 serial signal output.

Function	S_422 Pin#
<b>RS232 (Default)</b>	<b>OFF: Pin1, Pin2, Pin3, Pin4</b>
RS422 (option)	ON: Pin1, Pin2, Pin3, Pin4
RS485 (option)	ON: Pin1, Pin2, Pin3, Pin4

S-422	Mode
Pin11-12 ( Off )	ATX Power
Pin11-12 ( On )	<b>Auto Power on (Default)</b>

**19. COM1:**

(Type DB9),Rear serial port, standard DB9 Male serial port is provided to make a direct connection to serial devices. COM1 port is controlled by pins No.1~6 of JP1,select output Signal RI or 5V or 12V, For details, please refer to description of JP1 and S\_232 and S\_422 setting.



<b>RS232 (Default):</b>	
Pin#	Signal Name
1	DCD# (Data Carrier Detect)
2	RXD (Received Data)
3	TXD (Transmit Data)
4	DTR (Data Terminal Ready)
5	Ground
6	DSR (Data Set Ready)

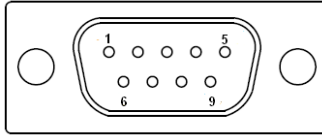
7	RTS (Request To Send)
8	CTS (Clear To Send)
9	<b>JP1 select Setting (RI/5V/12V)</b>
BIOS Setup : Advanced/W83627UHG Super IO Configuration/Serial Port 1 Configuration <b>【RS-232】</b>	

RS422 (option):	
Pin#	Signal Name
1	422_RX+
2	422_RX-
3	422_TX-
4	422_TX+
5	Ground
6	NC
7	NC
8	NC
9	NC
BIOS Setup : Advanced/W83627UHG Super IO Configuration/Serial Port 1 Configuration <b>【RS-422】</b>	

RS485 (option):	
Pin#	Signal Name
1	NC
2	NC
3	485-
4	485+
5	Ground
6	NC
7	NC
8	NC
9	NC
BIOS Setup : Advanced/W83627UHG Super IO Configuration/Serial Port 1 Configuration <b>【RS-485】</b>	

**21. COM2:**

**(Type DB9)**,Rear serial port, standard DB9 Male serial port is provided to make a direct connection to serial devices.



Pin#	Signal Name
1	DCD# (Data Carrier Detect)
2	RXD (Received Data)
3	TXD (Transmit Data)
4	DTR (Data Terminal Ready)
5	Ground
6	DSR (Data Set Ready)
7	RTS (Request To Send)
8	CTS (Clear To Send)
9	<b>JP2 select Setting (RI/5V/12V)</b>

## 22. JP4:

(2.0mm Pitch 2x2 wafer Pin Header), USB0(CN1) or Touch jumper setting.

JP4	Function	
	USB0 (CN1)	Touch(TCH1)
Close 3-4( <b>default</b> )	-	Yes
Open 3-4(option)	Yes	-
Open 1-2( <b>default</b> )	-	

## 23. TCH1:

(2.0mm Pitch 1x6 wafer Pin Header), internal Touch controller connector.

Pin#	Signal Name
1	SENSE
2	X+
3	X-
4	Y+
5	Y-
6	GND_EARCH

## 24. LED1, LED2, LED3 (option):

LED1: LED STATUS. Green LED for Motherboard Power status.

LED2: LED STATUS. Green LED for Motherboard Standby Power Good status.

LED3: LED STATUS. Green LED for Touch Power status.

## 25. SATA\_P:

(2.5mm Pitch 1x2 box Pin Header), One onboard 5V output connector are reserved to provide power for SATA devices.

Pin#	Signal Name
1	+DC5V
2	Ground



**Note:**

**Output current of the connector must not be above 1A.**

**26. SATA2:**

(SATA 7Pin), SATA Connectors, one SATA connector are provided, with transfer speed up to 3.0Gb/s.

**27. SATA1:**

(SATA 7Pin+15Pin), SATA Connectors, one SATA connector are provided, with transfer speed up to 3.0Gb/s.

**28. SD1:**

(SD card socket),Secure Digital Memory Card socket.

**29. MPCIE1:**

(Socket 52Pin),mini PCIe socket, it is located at the top, it supports mini PCIe devices with USB2.0 and LPC and SMBUS and PCIe signal. MPCIE card size is 30x30mm.

**30. H1/H2:**

MPCIE1 SCREW HOLES, H1and H2 for mini PCIE card (30mmx30mm) assemble.

**31. AUDIO:**

(2.0mm Pitch 2X6 Pin Header), Front Audio, An onboard Realtek ALC662 codec is used to provide high-quality audio I/O ports. Line Out can be connected to a headphone or amplifier. Line In is used for the connection of external audio source via a Line in cable. MIC is the port for microphone input audio.

Signal Name	Pin#	Pin#	Signal Name
+5V	1	2	GND_AUD
LINE-OUT-L	3	4	LINE-OUT-R
FRONT_JD	5	6	LINE1_JD
LINE-IN-L	7	8	LINE-IN-R
MIC-IN-L	9	10	MIC-IN-R
GND_AUD	11	12	MIC1_JD

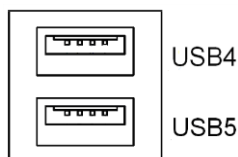
### 32. LINE\_OUT:

(Diameter 3.5mm Jack), HD Audio port, An onboard Realtek ALC662 codec is used to provide high quality audio I/O ports. Line Out can be connected to a headphone or amplifier.



### 33. USB45:

**USB4/USB5** : (Double stack USB type A), Rear USB connector, it provides up to 4 USB2.0 ports, High-speed USB 2.0 allows data transfers up to 480 Mb/s ,support USB full-speed and low-speed signaling.

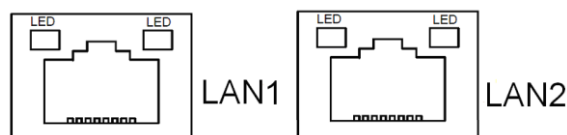


**Each USB Type A Receptacle (2 Ports) Current limited value is 1.5A.**

**If the external USB device current exceeds 1.5A, please separate connectors into different Receptacle.**

### 34. LAN1/LAN2:

**LAN1/LAN2:** (RJ45 Connector), Rear LAN port, Two standard 10/100/1000M RJ-45 Ethernet ports are provided. Used intel 82574L chipset, LINK LED (green) and ACTIVE LED (yellow) respectively located at the left-hand and right-hand side of the Ethernet port indicate the activity and transmission state of LAN.



### 35. BUZ1:

Onboard buzzer.

### 36. CN2:

([DF13-30P](#) Connector),For expand output connector, It provides eight GPIO,one RS422 or RS485,one USB2.0,one Power on/off, one Reset.

Function	Signal Name	Pin#	Signal Name	Function
5V	5V_S5	2   1	5V_S5	5V
SIO_GPIO61	GPIO_IN2	4   3	GPIO_IN1	SIO_GPIO60
SIO_GPIO63	GPIO_IN4	6   5	GPIO_IN3	SIO_GPIO62

SIO_GPIO21	GPIO_OUT2	8	7	GPIO_OUT1	SIO_GPIO20
SIO_GPIO23	GPIO_OUT4	10	9	GPIO_OUT3	SIO_GPIO22
	Ground	12	11	Ground	
485 or 422	485+_422TX+	14	13	485-_422TX-	485 or 422
RS422	422_RX+	16	15	422_RX-	RS422
	NC	18	17	NC	
	NC	20	19	NC	
5V	5V_S0	22	21	HDD_LED+	HDD LED
USB2.0	5V_USB01	24	23	5V_USB01	USB2.0
	USB1_P	26	25	USB1_N	
	Ground	28	27	FP_RST-	RESET
Power auto on	PWRBTN_ON	30	29	Ground	
COM3 BIOS Setup :					
Advanced/W83627UHG Super IO Configuration/Serial Port 3 Configuration					
【RS-422】					
Advanced/W83627UHG Super IO Configuration/Serial Port 3 Configuration					
【RS-485】					

### 37. CN3:

(1.27mm Pitch 2X30 Pin Header), For expand output connector, It provides four GPIO, two USB 2.0, one PS/2 mouse , one PS/2 keyboard, two uart, one PCIe x1, one SMBus. connected to the TB-528 riser Card.

Function	Signal Name	Pin#		Signal Name	Function
	5V_S5_USB	1	2	5V_S5_USB	
	5V_S5_USB	3	4	5V_S5_USB	
	USB23_OC	5	6	CLKREQPSON_ATX-	
USB2	USB2_N	7	8	USB2_P	USB2
USB3	USB3_N	9	10	USB3_P	USB3
	Ground	11	12	Ground	
PS/2 MS	PS2_MSCLK	13	14	PS2_MSDATA	PS/2 MS
PS/2 KB	PS2_KBCLK	15	16	PS2_KBDATA	PS/2 KB
COM6 (UART)	COM6_RI	17	18	COM6_DCD-	COM6 (UART)
	COM6_TXD	19	20	COM6_RXD	
	COM6_DTR	21	22	RICOM6_RTS-	
	COM6_DSR	23	24	COM6_CTS-	
	Ground	25	26	Ground	
COM5 (UART)	COM5_RI	27	28	COM5_DCD-	COM5 (UART)
	COM5_TXD	29	30	COM5_RXD	
	COM5_DTR	31	32	DSRCOM5_RTS-	

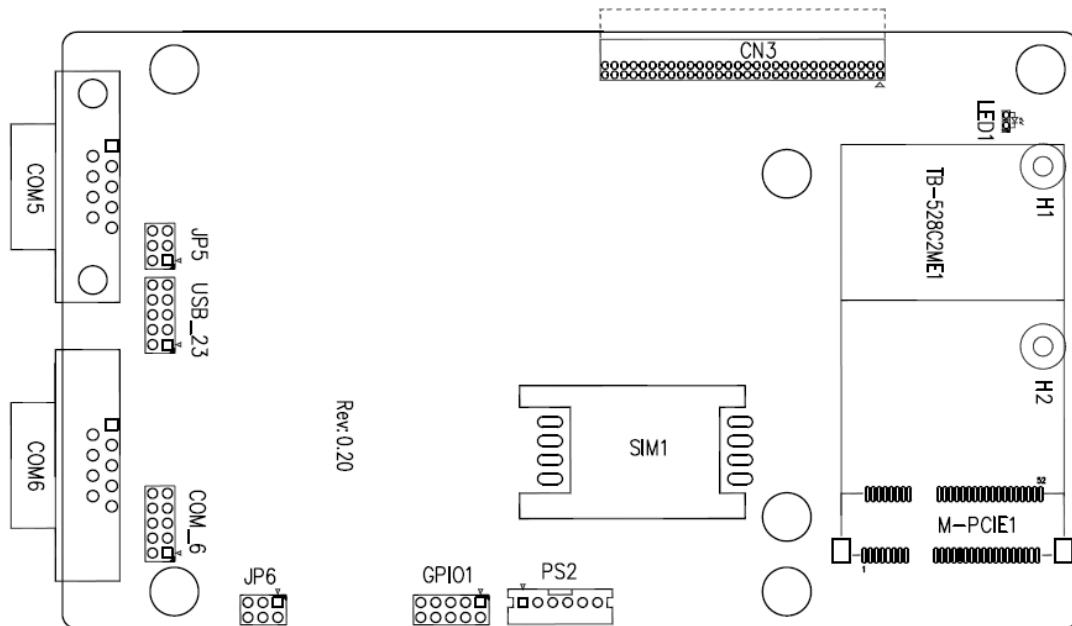


	COM5_DSR	33	34	DTRCOM5_CTS-	
GPIO24	ICH_GPIO24	35	36	ICH_GPIO13	GPIO13
GPIO26	ICH_GPIO26	37	38	ICH_GPIO27	GPIO27
	Ground	39	40	Ground	
PCIE	PE1_TX_N0	41	42	PE1_TX_P0	PCIE
	PE1_RX_N0	43	44	PE1_RX_P0	
	Ground	45	46	Ground	
	CLK_100M_PE1_N	47	48	CLK_100M_PE1_P	
	PM_PCIE_WAKE	49	50	PLTRST_BUF-	
SMBUS	SMB_CLK_S5	51	52	SMB_DATA_S5	SMBUS
PCIE	PE1_CLKREQ	53	54	Ground	
	3P3V_S5	55	56	PWRBTN_ON-	Power Auto on
	3P3V_S5	57	58	3P3V_S5	
12V	12V_S0	59	60	12V_S0	12V

**38. TB-528C2ME1 (option):**

SBC-7106A Riser Card, TB-528C2ME1 CN3 connect to SBC-7106A CN3 pin Header.

TB-528C2ME1 Top :



**CN3 :**

(1.27mm Pitch 2X30 Pin Header), connect to SBC-7106A CN3 pin Header.

**M-PCIE1 :**

(Socket 52Pin), mini PCIe socket, it is located at the top, it supports mini PCIe devices with **USB2.0(USB2)**, Smbus, SIM and PCIe signal. MPCle card size is 30x30mm or 30x50.95mm.

Signal Name	Function support
PCIe 1X	Yes
USB2.0 (USB2)	Yes
SMBus	Yes
SIM	Yes

**H1/H2:**

MPCIE1 SCREW HOLES, H2 for mini PCIE card (30mmx30mm) assemble. H1 for mini PCIE card (30mmx50.95mm) assemble.

**LED1 :**

Mini PCIe devices LED Status.

**SIM1 :**

(SIM Socket 6 Pin), Support SIM Card devices.

**PS2 :**

(2.0mm Pitch 1X6 Pin Wafer), PS/2 keyboard and mouse port, the port can be connected to PS/2 keyboard or mouse via a dedicated cable for direct used.

Pin#	Signal Name
1	KBDATA
2	MSDATA
3	Ground
4	+5V
5	KBCLK
6	MSCLK

**GPIO1 :**

(2.0mm Pitch 2x5 Pin Header), General-purpose input/output port, it provides a group of self-programming interfaces to customers for flexible use.

Signal Name	Pin#	Pin#	Signal Name
Ground	1	2	NC
NC	3	4	SMB_DATA_R
SMB_CLK_R	5	6	ICH_GPIO13_IN1
ICH_GPIO24_IN2	7	8	ICH_GPIO26_IN3
ICH_GPIO27_IN4	9	10	+5V

**USB\_23 :**

(2.0mm Pitch 2x5 Pin Header) ,Front USB connector, it provides one USB port via a dedicated USB cable, speed up to 480Mb/s.

Signal Name	Pin#	Pin#	Signal Name
5V_USB23	1	2	5V_USB23
USB3_N	3	4	<b>USB2_N ( option, NC )</b>
USB3_P	5	6	<b>USB2_P ( option, NC )</b>
Ground	7	8	Ground
NC	9	10	Ground

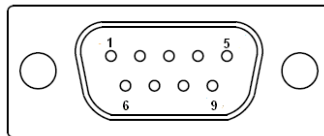


**Note:**

Before connection, make sure that pinout of the USB Cable is in accordance with that of the said tables. Any inconformity may cause system down and even hardware damages.

**COM5 :**

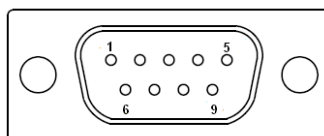
(Type DB9),serial port, standard DB9 serial port is provided to make a direct connection to serial devices. COM5 port is controlled by pins No.1~6 of **JP5**,select output Signal RI or 5V or 12v, For details, please refer to description of JP3.



Pin#	Signal Name
1	DCD# (Data Carrier Detect)
2	RXD (Received Data)
3	TXD (Transmit Data)
4	DTR (Data Terminal Ready)
5	Ground
6	DSR (Data Set Ready)
7	RTS (Request To Send)
8	CTS (Clear To Send)
9	NA

**COM6 :**

(Type DB9),serial port, standard DB9 serial port is provided to make a direct connection to serial devices. COM6 port is controlled by pins No.1~6 of **JP6**,select output Signal RI or 5V or 12v, For details, please refer to description of JP6.



Pin#	Signal Name
1	DCD# (Data Carrier Detect)
2	RXD (Received Data)

3	TXD (Transmit Data)
4	DTR (Data Terminal Ready)
5	Ground
6	DSR (Data Set Ready)
7	RTS (Request To Send)
8	CTS (Clear To Send)
9	NA

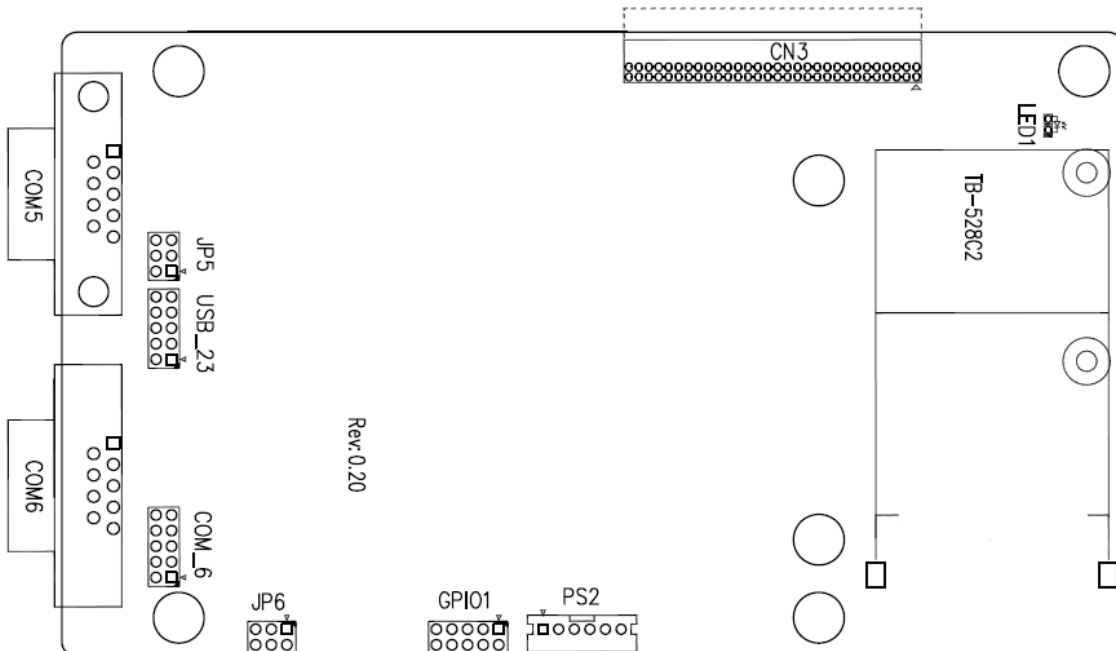
**COM\_6 (option) :**

(2.0mm Pitch 2X5 Pin Header),COM6 Port, up to one standard RS232 port are provided. They can be used directly via COM cable connection.

Signal Name	Pin#	Pin#	Signal Name
DCD	1	2	RXD
TXD	3	4	DTR
Ground	5	6	DSR
RTS	7	8	CTS
JP6 Setting: RI/5V/12V	9	10	NC

**39. TB-528C2 (option):**

SBC-7106A Riser Card,TB-528C2ME1 CN3 connect to SBC-7106A CN3 pin Header. TB-528C2ME1 Top :



**CN3 :**

(1.27mm Pitch 2X30 Pin Header),connect to SBC-7106A CN3 pin Header.

**LED1 :**

Mini PCIe devices LED Status.

**PS2 :**

(2.0mm Pitch 1X6 Pin Wafer), PS/2 keyboard and mouse port, the port can be connected to PS/2 keyboard or mouse via a dedicated cable for direct used.

Pin#	Signal Name
1	KBDATA
2	MSDATA
3	Ground
4	+5V
5	KBCLK
6	MSCLK

**GPIO1 :**

(2.0mm Pitch 2x5 Pin Header), General-purpose input/output port, it provides a group of self-programming interfaces to customers for flexible use.

Signal Name	Pin#	Pin#	Signal Name
Ground	1	2	NC
NC	3	4	SMB_DATA_R
SMB_CLK_R	5	6	ICH_GPIO13_IN1
ICH_GPIO24_IN2	7	8	ICH_GPIO26_IN3
ICH_GPIO27_IN4	9	10	+5V

**USB\_23 :**

(2.0mm Pitch 2x5 Pin Header) ,Front USB connector, it provides one USB port via a dedicated USB cable, speed up to 480Mb/s.

Signal Name	Pin#	Pin#	Signal Name
5V_USB23	1	2	5V_USB23
USB3_N	3	4	USB2_N
USB3_P	5	6	USB2_P
Ground	7	8	Ground
NC	9	10	Ground

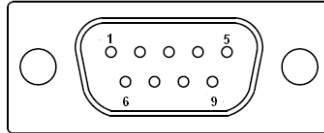
**Note:**

Before connection, make sure that pinout of the USB Cable is in accordance with that of the said tables. Any inconformity may cause system down and even hardware damages.

**COM5 :**

(Type DB9), serial port, standard DB9 serial port is provided to make a direct connection

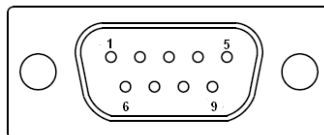
to serial devices. COM5 port is controlled by pins No.1~6 of **JP5**,select output Signal RI or 5V or 12v, For details, please refer to description of JP3.



Pin#	Signal Name
1	DCD# (Data Carrier Detect)
2	RXD (Received Data)
3	TXD (Transmit Data)
4	DTR (Data Terminal Ready)
5	Ground
6	DSR (Data Set Ready)
7	RTS (Request To Send)
8	CTS (Clear To Send)
9	NA

**COM6 :**

(Type DB9),serial port, standard DB9 serial port is provided to make a direct connection to serial devices. COM6 port is controlled by pins No.1~6 of **JP6**,select output Signal RI or 5V or 12v, For details, please refer to description of JP6.



Pin#	Signal Name
1	DCD# (Data Carrier Detect)
2	RXD (Received Data)
3	TXD (Transmit Data)
4	DTR (Data Terminal Ready)
5	Ground
6	DSR (Data Set Ready)
7	RTS (Request To Send)
8	CTS (Clear To Send)
9	NA

**COM\_6 ( option ) :**

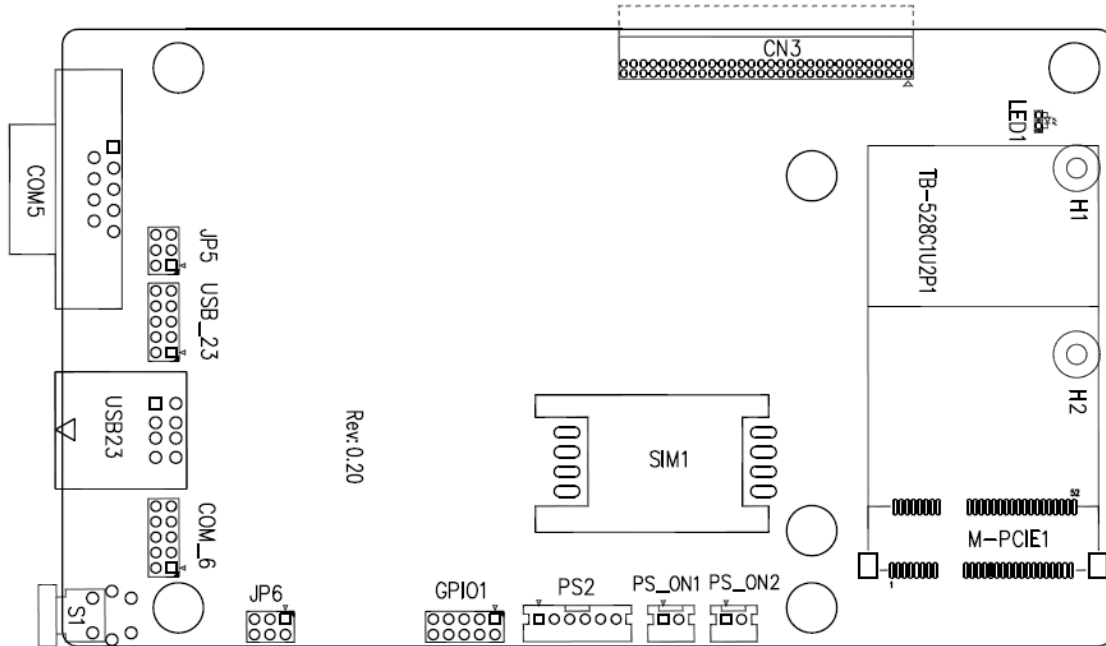
(2.0mm Pitch 2X5 Pin Header),COM6 Port, up to one standard RS232 port are provided. They can be used directly via COM cable connection.

Signal Name	Pin#	Pin#	Signal Name
DCD	1	2	RXD
TXD	3	4	DTR
Ground	5	6	DSR
RTS	7	8	CTS
JP6 Setting: RI/5V/12V	9	10	NC

**40. TB-528C1U2P1/TB-528C1U2 (option):**

SBC-7106A Riser Card, TB-528C1U2P1 CN3 connect to SBC-7106A CN3 pin Header.

TB-528C1U2P1 Top :



**CN3 :**

(1.27mm Pitch 2X30 Pin Header), connect to SBC-7106A CN3 pin Header.

**M-PCIE1 :**

(Socket 52Pin), mini PCIe socket, it is located at the top, it supports mini PCIe devices with Smbus, SIM and PCIe signal. MPCIE card size is 30x30mm or 30x50.95mm.

Signal Name	Function support
PCIe 1X	Yes
USB2.0 (USB2)	<b>NC (option)</b>
SMBus	Yes
SIM	Yes

**H1/H2:**

MPCIE1 SCREW HOLES, H2 for mini PCIE card (30mmx30mm) assemble. H1 for mini PCIE card (30mmx50.95mm) assemble.

**LED1 :**

Mini PCIe devices LED Status.

**SIM1 ( option ) :**

(SIM Socket 6 Pin), Support SIM Card devices.

**PS\_ON1 :**

(2.0mm Pitch 1X2 Pin Wafer), ATX Power and Auto Power on jumper setting.

PS_ON	Mode
<b>Close 1-2</b>	<b>Auto Power on (Default)</b>
Open 1-2	ATX Power

**PS\_ON2 ( option ) :**

(2.0mm Pitch 1X2 Pin Wafer), They can be used directly via cable connection to SBC-7106A JP5.

PS_ON2	SBC-7106A /JP5
Pin1	Pin1
Pin2	Pin2

**PS2 :**

(2.0mm Pitch 1X6 Pin Wafer), PS/2 keyboard and mouse port, the port can be connected to PS/2 keyboard or mouse via a dedicated cable for direct used.

Pin#	Signal Name
1	KBDATA
2	MSDATA
3	Ground
4	+5V
5	KBCLK
6	MSCLK

**GPIO1 :**

(2.0mm Pitch 2x5 Pin Header), General-purpose input/output port, it provides a group of self-programming interfaces to customers for flexible use.

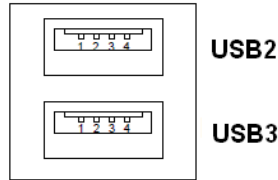
Signal Name	Pin#	Pin#	Signal Name
Ground	1	2	NC
NC	3	4	SMB_DATA_R
SMB_CLK_R	5	6	ICH_GPIO13_IN1



ICH_GPIO24_IN2	7	8	ICH_GPIO26_IN3
ICH_GPIO27_IN4	9	10	+5V

### USB23 :

(Double stack USB type A), Rear USB connector, it provides up to 2 USB2.0 ports, speed up to 480Mb/s.



### USB\_23 ( option ) :

(2.0mm Pitch 2x5 Pin Header) ,Front USB connector, it provides one USB port via a dedicated USB cable, speed up to 480Mb/s.

Signal Name	Pin#	Pin#	Signal Name
5V_USB23	1	2	5V_USB23
USB3_N	3	4	USB2_N
USB3_P	5	6	USB2_P
Ground	7	8	Ground
NC	9	10	Ground

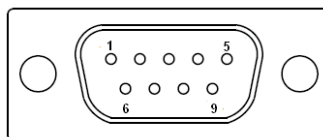


### Note:

Before connection, make sure that pinout of the USB Cable is in accordance with that of the said tables. Any inconformity may cause system down and even hardware damages.

### COM5 :

(Type DB9),serial port, standard DB9 serial port is provided to make a direct connection to serial devices. COM5 port is controlled by pins No.1~6 of **JP5**,select output Signal RI or 5V or 12v, For details, please refer to description of JP3.

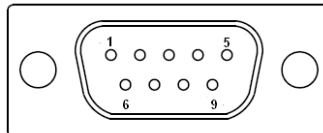


Pin#	Signal Name
1	DCD# (Data Carrier Detect)
2	RXD (Received Data)
3	TXD (Transmit Data)
4	DTR (Data Terminal Ready)

5	Ground
6	DSR (Data Set Ready)
7	RTS (Request To Send)
8	CTS (Clear To Send)
9	NA

**COM6 :**

(Type DB9),serial port, standard DB9 serial port is provided to make a direct connection to serial devices. COM6 port is controlled by pins No.1~6 of **JP6**,select output Signal RI or 5V or 12v, For details, please refer to description of JP6.



Pin#	Signal Name
1	DCD# (Data Carrier Detect)
2	RXD (Received Data)
3	TXD (Transmit Data)
4	DTR (Data Terminal Ready)
5	Ground
6	DSR (Data Set Ready)
7	RTS (Request To Send)
8	CTS (Clear To Send)
9	NA

**S1 :**

**PWR BT: POWER on/off Button**, They are used to connect power switch button. The two pins are disconnected under normal condition. You may short them temporarily to realize system startup & shutdown or awaken the system from sleep state.

**PWR LED: POWER LED status.**

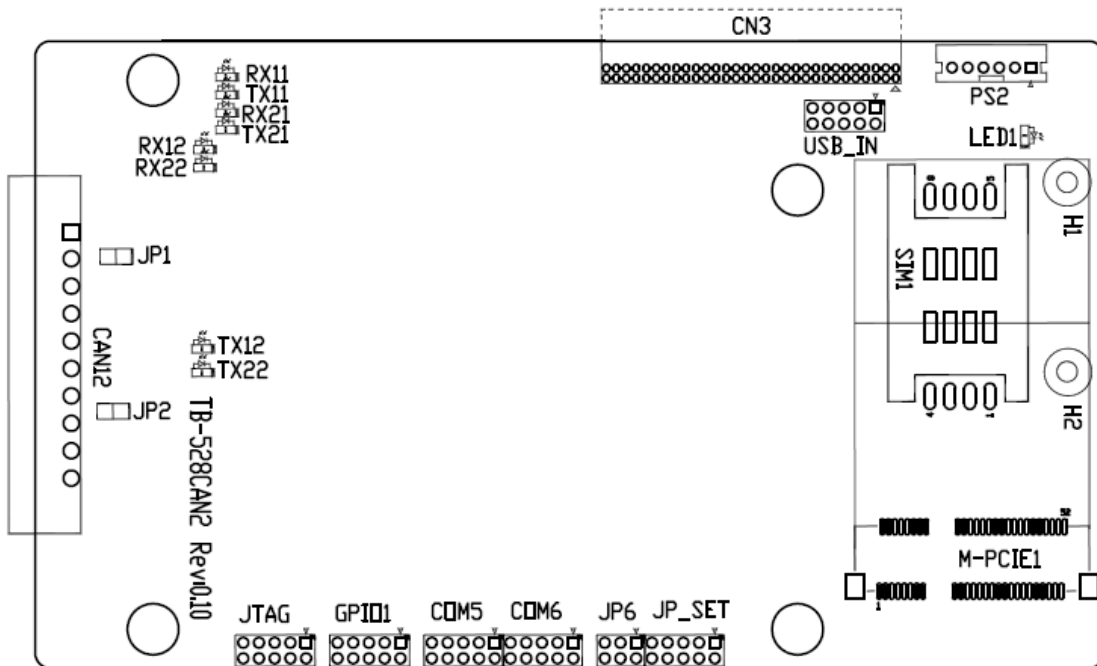
S1	Model
Yes	TB-528C1U2P1
No	TB-528C1U2

**41. TB-528CAN2 R0.10 (option):**

SBC-7106A Riser Card,TB-528CAN2 CN3 connect to SBC-7106A CN3 pin Header.

It provides two CAN-bus Interface.

TB-528CAN2 Top :



**CN3 :**

(1.27mm Pitch 2X30 Pin Header),connect to SBC-7106A CN3 pin Header.

**M-PCIE1 :**

(Socket 52Pin),mini PCIe socket, it is located at the top, it supports mini PCIe devices with Smbus,USB2.0,SIM and PCIe signal. MPCie card size is 30x30mm or 30x50.95mm.

Signal Name	Function support
PCIe 1X	Yes
USB2.0 (USB2)	Yes
SMBus	Yes
SIM	Yes

**H1/H2:**

MPCIE1 SCREW HOLES, H2 for mini PCIe card (30mmx30mm) assemble. H1 for mini PCIe card (30mmx50.95mm) assemble.

**LED1 :**

Mini PCIe devices LED Status.

**SIM1 ( option ) :**

(SIM Socket 6 Pin), Support SIM Card devices.

**PS2 :**

(2.0mm Pitch 1X6 Pin Wafer), PS/2 keyboard and mouse port, the port can be connected to PS/2 keyboard or mouse via a dedicated cable for direct used.

Pin#	Signal Name
1	KBDATA
2	MSDATA
3	Ground
4	+5V
5	KBCLK
6	MSCLK

**USB\_IN ( option ) :**

(2.0mm Pitch 2x5 Pin Header) ,Front USB connector, it provides two USB port via a dedicated USB cable, speed up to 480Mb/s.

Signal Name	Pin#	Pin#	Signal Name
5V_USB23	1	2	5V_USB23
NC (USB3_N)	3	4	NC (USB2_N)
NC (USB3_P)	5	6	NC (USB2_P)
Ground	7	8	Ground
NC	9	10	Ground



**Note:**

Before connection, make sure that pinout of the USB Cable is in accordance with that of the said tables. Any inconformity may cause system down and even hardware damages.

**JP\_SET (option):**

(2.0mm Pitch 2x5 Pin Header).

Signal Name	Pin#	Pin#	Signal Name
3P3V_S5_USB	1	2	3P3V_S5
3P3V_S5_USB	3	4	3P3V_S5
3P3V_S5_USB	5	6	3P3V_S5
PSON_ATX	7	8	Ground
PSON_ATX	9	10	Ground

**COM6 :**

(2.0mm Pitch 2X5 Pin Header),COM6 Port, up to one standard RS232 port are provided. They can be used directly via COM cable connection.

Signal Name	Pin#	Pin#	Signal Name
DCD	1	2	RXD
TXD	3	4	DTR
Ground	5	6	DSR
RTS	7	8	CTS
JP6 Setting : RI/5V/12V	9	10	NC

#### **COM5:**

(2.0mm Pitch 2X5 Pin Header), COM5 Port, up to one standard RS232 port are provided. They can be used directly via COM cable connection.

Signal Name	Pin#	Pin#	Signal Name
DCD	1	2	RXD
TXD	3	4	DTR
Ground	5	6	DSR
RTS	7	8	CTS
RI	9	10	NC

#### **GPIO1 :**

(2.0mm Pitch 2x5 Pin Header), General-purpose input/output port, it provides a group of self-programming interfaces to customers for flexible use.

Signal Name	Pin#	Pin#	Signal Name
Ground	1	2	NC
NC	3	4	SMB_DATA_R
SMB_CLK_R	5	6	ICH_GPIO13_IN1
ICH_GPIO24_IN2	7	8	ICH_GPIO26_IN3
ICH_GPIO27_IN4	9	10	+5V

#### **JTAG :**

(2.0mm Pitch 2x5 Pin Header), Reserve.

#### **JP1 :**

(2.0mm Pitch 1x2 Pin Header), Reserve.

#### **JP2 :**

(2.0mm Pitch 1x2 Pin Header), Reserve.

#### **CAN1/CAN2 :**

(3.5mm Pitch 1x10 Pin connector), it provides two CAN-bus Interface.

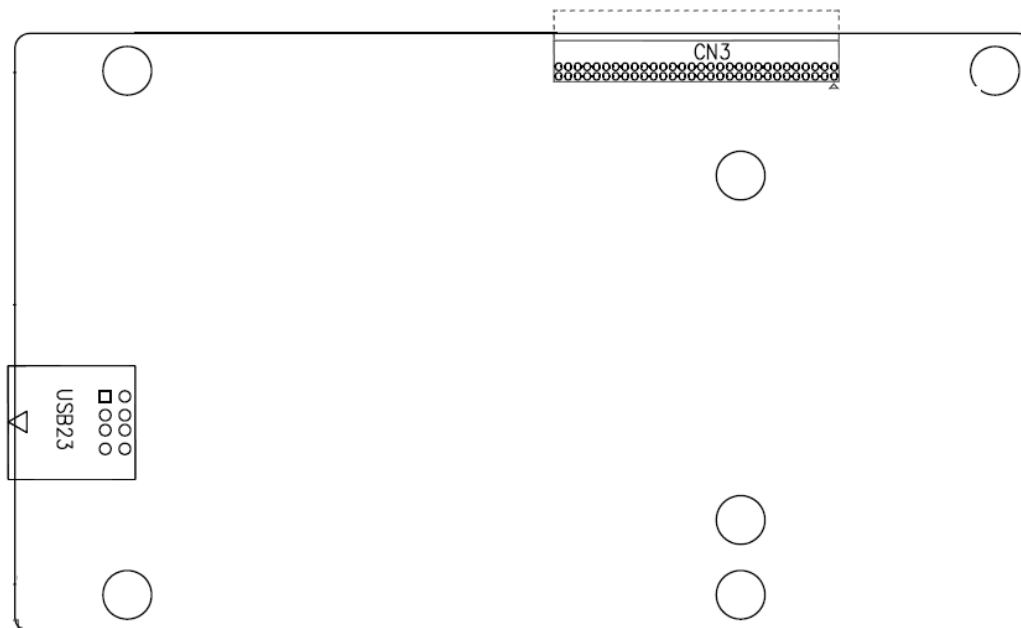
Pin#	Channel	Signal Name	Function
1	CAN2	CANL2	CAN bus Signal L
2		R2-	Terminal resistor R-(internally connected to CANL2)
3		FG	Shield cable (FG)
4		R2+	Terminal resistor R+( internally connected to CANH2)
5		CANH2	CAN bus Signal H
6	CAN1	CANL1	CAN bus Signal L
7		R1-	Terminal resistor R-(internally connected to CANL1)
8		FG	Shield cable (FG)
9		R1+	Terminal resistor R+( internally connected to CANH1)
10		CANH1	CAN bus Signal H

【 See TB-528AN2 Manual 】

#### 42. TB-528U2 (option):

SBC-7106A Riser Card, TB-528U2 CN3 connect to SBC-7106A CN3 pin Header.

TB-528U2 Top :

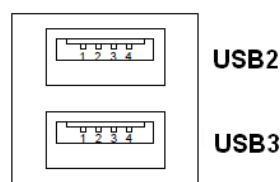


#### CN3 :

(1.27mm Pitch 2X30 Pin Header), connect to SBC-7106A CN3 pin Header.

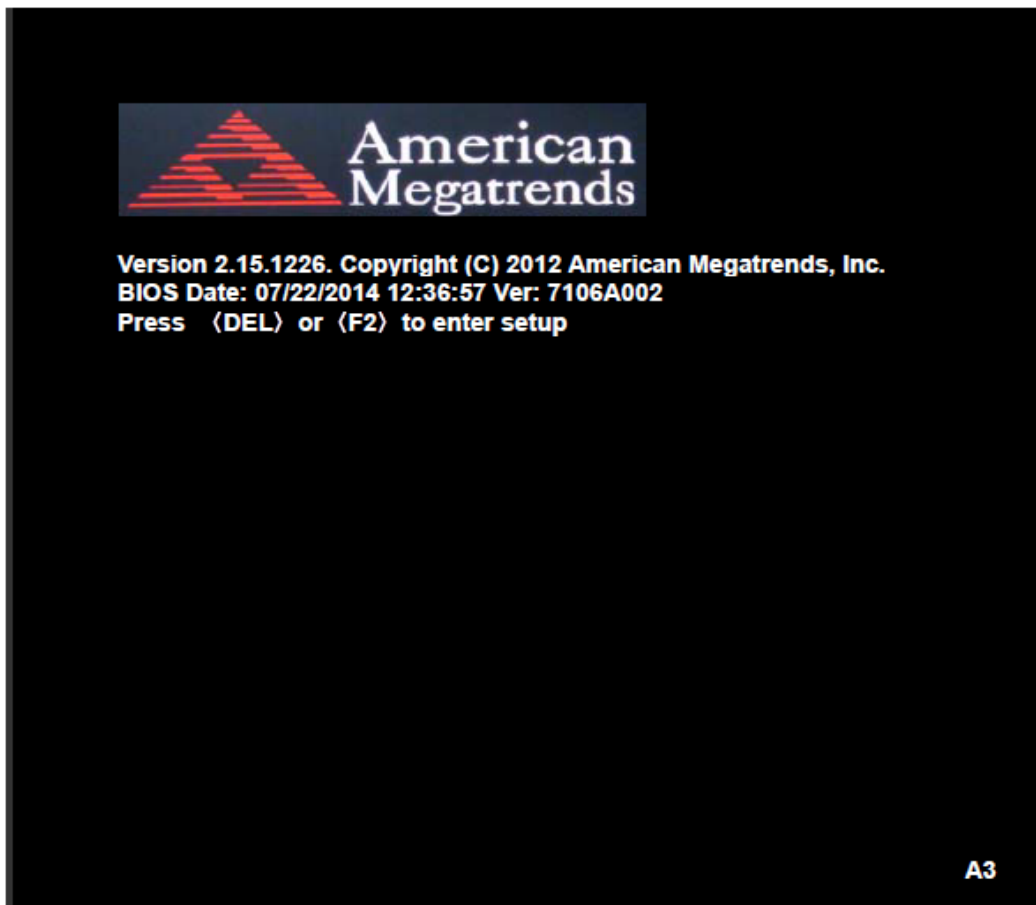
#### USB23 :

(Double stack USB type A), Rear USB connector, it provides up to 2 USB2.0 ports, speed up to 480Mb/s.



## 3.1 Operations after POST Screen

After CMOS discharge or BIOS flashing operation, Press [Delete] key to enter CMOS Setup.



After optimizing and exiting CMOS Setup, the POST screen displayed for the first time is as follows and includes basic information on BIOS, CPU, memory, and storage devices.

## 3.2 BIOS Setup Utility

Press [Delete] key to enter BIOS Setup utility during POST, and then a main menu containing system summary information will appear.

Aptio Setup Utility – Copyright (C) 2012 American Megatrends, Inc.					
Main	Advanced	Chipset	Boot	Security	Save & Exit
BIOS Information BIOS Vendor            American Megatrends Core Version            4.6.5.3 Compliancy            UEFI 2.3; PI 1.2 Project Version        7106A002 x64 Build Date and Time    07/22/2014 12:36:57 ▶ Intel RC Version					Intel Reference Code Version
System Language        [English]  System Date            [Sun 01/01/2012] System Time            [00:00:08]  Access Level            Administrator					→←: Select Screen ↑↓ : Select Item Enter: Select +/- : Change Opt. F1 : General Help F2: Previous Values F3:Optimized Defaults F4:Save and Exit ESC Exit
Version 2.15.1226. Copyright (C) 2012 American Megatrends , Inc.					

### 3.3 Main Settings

BIOS Information BIOS Vendor            American Megatrends Core Version            4.6.5.3 Compliancy            UEFI 2.3; PI 1.2 Project Version        7106A002 Build Date and Time    07/22/2014 12:36:57 ▶ Intel RC Version					Intel Reference Code Version
System Language        [English]  System Date            [Sun 01/01/2012] System Time            [00:00:08]  Access Level            Administrator					→←: Select Screen ↑↓ : Select Item Enter: Select +/- : Change Opt. F1 : General Help F2: Previous Values F3:Optimized Defaults F4:Save and Exit ESC Exit
Version 2.15.1226. Copyright (C) 2012 American Megatrends , Inc.					



### System Time:

Set the system time, the time format is:

Hour : 0 to 23

Minute : 0 to 59

Second : 0 to 59

### System Date:

Set the system date, the date format is:

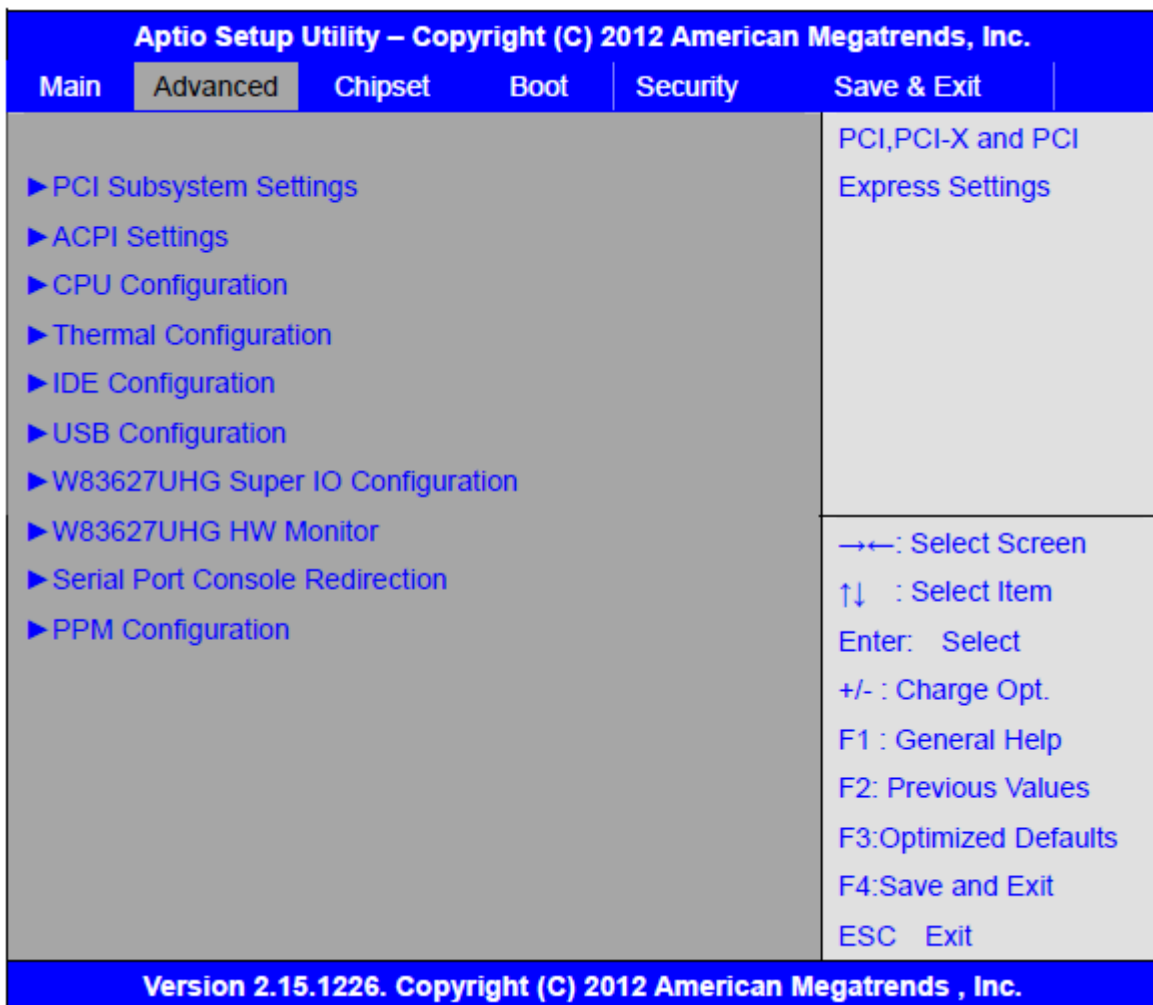
**Day:** Note that the 'Day' automatically changes when you set the date.

**Month:** 01 to 12

**Date:** 01 to 31

**Year:** 1998 to 2099

## 3.4 Advanced Settings



### 3.4.1 PCI Subsystem Settings

PCI Bus Driver Versio V2.05.02

**PCI Common Settings:**

**PCI Latency Timer:**

**[32 PCI Bus Clocks]**

[64 PCI Bus Clocks]

[96 PCI Bus Clocks]

[128 PCI Bus Clocks]

[160 PCI Bus Clocks]

[192 PCI Bus Clocks]

[224 PCI Bus Clocks]

[248 PCI Bus Clocks]

**VGA Palette Snoop:**

**[Disabled]**

[Enabled]

**PERR# Generation:**

**[Disabled]**

[Enabled]

**SERR# Generation:**

**[Disabled]**

[Enabled]

### **3.4.2 ACPI Settings**

**Enable ACPI Auto Conf:**

**[Disabled]**

[Enabled]

**Enable Hibernation:**

**[Enabled]**

[Disabled]

**ACPI Sleep State:**

**[Both S1 and S3 available for OS to choose from ]**

[Suspend Disabled]

[S1 only(CPU Stop Clock) ]

[S3 only (Suspend to RAM) ]

**Lock Legacy Resources:**

**[Disabled]**

[Enabled]

### S3 Video Repost:

[Disabled]

[Enabled]

### 3.4.3 CPU Configuration

Processor Type	Intel(R) Atom™ CPU D2550
EMT64	Supported
Processor Speed	1865 MHz
System Bus Speed	533MHz
Ratio Status	14
Actual Ratio	14
System Bus Speed	533 MHz
Processor Stepping	30661
Microcode Revision	269
L1 Cache RAM	2x56 k
L2 Cache RAM	2x512 k
Processor Core	Dual
Hyper-Threading	Supported

Hyper-Threading:

[Enabled]

[Disabled]

Execute Disable Bit:

[Enabled]

[Disabled]

Limit CPUID Maximum:

[Disabled]

[Enabled]

### 3.4.4 Thermal Configuration

CPU Thermal Configuration

DTS SMM

[Disabled]

[Enabled]

Platform Thermal Configuration

Critical Trip Point [POR]

Active Trip Point Lo [55 C]

Active Trip Point Hi [71C]  
 Passive Trip Point [95]  
 Passive TC1 Value 1  
 Passive TC2 Value 5  
 Passive TSP Value 10

### 3.4.5 IDE Configuration

SATA Port0 Not Present  
 SATA Port1 Not Present

#### SATA Controller(S):

[Enabled]  
 [Disabled]

#### Configure SATA as:

[IDE]  
 [AHCI]

#### Misc Configuration for hard disk

### 3.4.6 USB Configuration

USB Configuration

USB Devices:

1 keyboard, 1 Mouse , 1 Point

Legacy USB Support:

[Enabled]  
 [Disabled]

EHCI Hand-off:

[Disabled]  
 [Enabled]

USB hardware delays a

USB transfer time-out:

[20 sec]  
 [10 sec]  
 [5 sec]  
 [1 sec]

Device reset time-out:

[20 sec]  
 [10 sec]  
 [30 sec]  
 [40 sec]

Device power-up delay

[Auto]  
[Manual]

### 3.4.7 W83627UHG Super IO Configuration

W83627UHG Super IO ch W83627UHG

Serial Port 1 Configuration

UART Mode Selection :

**[RS-232]**

[RS-485]

[RS-422]

Serial Port 2 Configuration

Serial Port 3 Configuration

UART Mode Selection :

**[RS-485]**

[RS-422]

Serial Port 4 Configuration

Serial Port 5 Configuration

Serial Port 6 Configuration

### 3.4.8 W83627UHG HW Monitor

PC Health Status

System temperature1	: +38
SystemFan Speed	: N/A
CPUFan Speed	: N/A
VCORE	: +1.224V
+12V	: +12.512V
+3.3V	: +3.2888V
+1.5V	: +1.528V
AVCC	: +5.203V
VCC5V	: +5.216V
VSb5	: +5.203V
VBAT	: +3.334V

### 3.4.9 Serial Port Console Redirection

COM0

Console Redirection

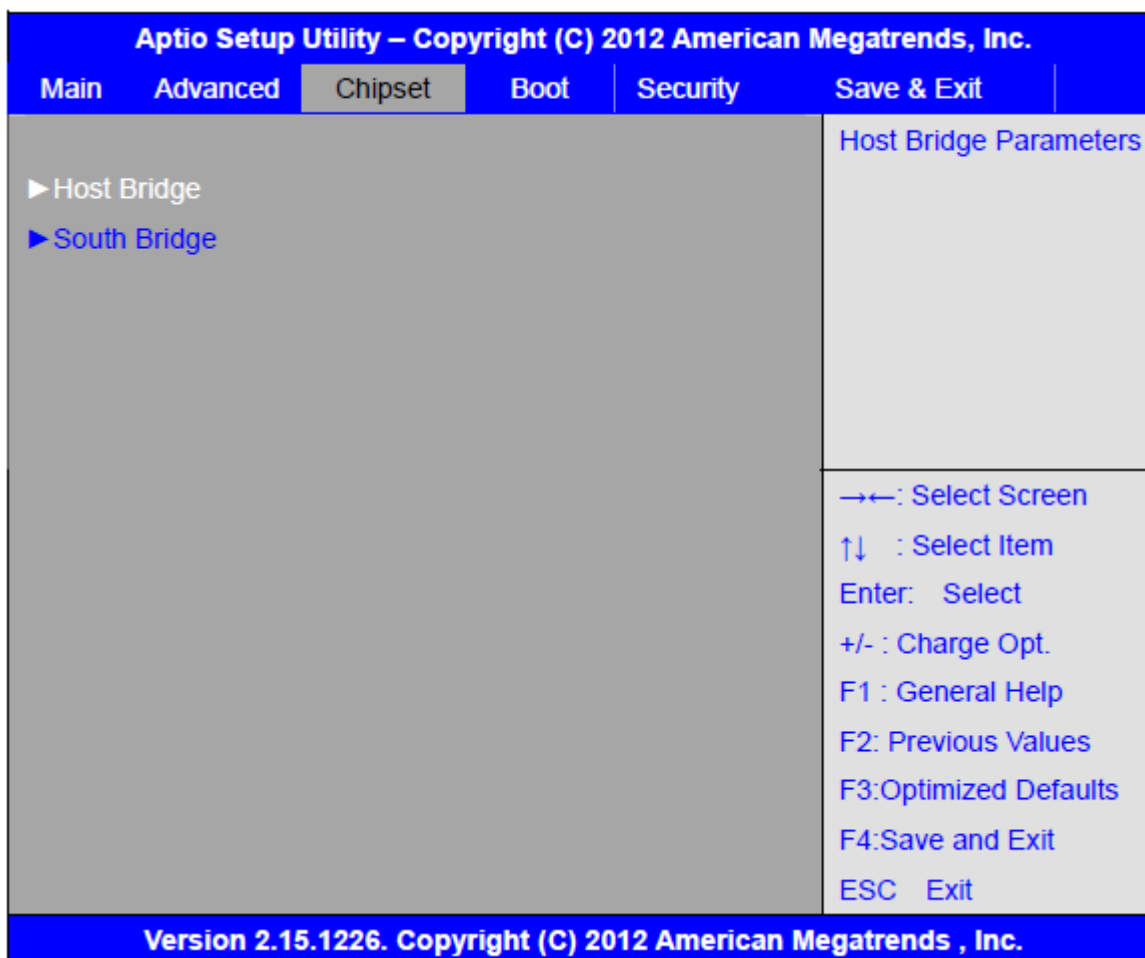
[Enabled]

	[Disabled]
Console Redirection Settings	
Serial Port for Out-of-Band Management/ Windows Emergency Management Services (EMS)	
Console Redirection	
	[Disabled]
	[Enabled]
Console Redirection Settings	

### 3.4.10 PPM Configuration

PPM Configuration	
EIST:	
	[Enabled]
	[Disabled]
CPU C state Report	
	[Enabled]
	[Disabled]
Enhanced C state	
	[Enabled]
	[Disabled]
CPU Hard C4E	
	[Enabled]
	[Disabled]
CPU C6 state	
	[Enabled]
	[Disabled]
C4 Exit Timing	
	[Fast]
	[Default]
	[Slow]
C-state POPDOWN	
	[Enabled]
	[Disabled]
C-state POPUP	
	[Enabled]
	[Disabled]

## 3.5 Chipset Settings



### 3.5.1 Host Bridge

- ▶ Memory Frequency and Timing
- ▶ Intel IGD Configuration

\*\*\*\*\* Memory Information \*\*\*\*\*

Memory Frequency	1067 MHz(DDR3)
Total Memory	4096 MB
DIMM#0	Not Present
DIMM#1	4096 MB

#### Memory Frequency and Timing

MRC Fast Boot

**[Enabled]**  
[Disabled]

Max TOLUD

**[Dynamic]**  
[1GB]  
[1.25GB]

[1.5GB]  
[1.75GB]  
[2GB]  
[2.25GB]  
[2.5GB]  
[2.75GB]  
[3GB]  
[3.25GB]

## Intel IGD Configuration

IGFX – Boot Type

**[VBIOS Default]**  
[VGA]  
[HDMI]  
[LVDS]

LCD Panel Type

[VBIOS Default]

Panel Scaling

**[Auto]**  
[Force Scaling]  
[off]  
[Maintain Aspect Ratio]

Active LFP

**[LVDS]**  
[No LVDS]

IGD Clock Source

**[External Clock]**  
[Internal Clock]

Fixed Graphics Memory

[128MB]  
[256MB]

ALS Support

**[Disabled]**  
[Enabled]

Back light Control

**[DC]**  
[PWM]

Back light Logic

**[Positive]**



Back light Control Lev	[Negative]
	[Level 8]
	[Level 1]
	[Level 2]
	[Level 3]
	[Level 4]
	[Level 5]
	[Level 6]
	[Level 7]
	[Level 9]
	[Level 10]
	[Level 11]
	[Level 12]
	[Level 13]
	[Level 14]
	[Level 15]

### 3.5.2 South Bridge

TPT Devices	
PCI Express Root Port 0	
PCI Express Root Port 1	
PCI Express Root Port 2	
PCI Express Root Port 3	
DMI Link ASPM Control	[Enabled]
	[Disabled]
PCI-Exp. High Priorit	[Disabled]
	[Enabled]
High Precision Event Timer Configuration	
High Precision Timer	[Enabled]
	[Disabled]
SLP_S4 Assertion Widt	[1-2 Seconds]
	[2-3 Seconds]
	[3-4 Seconds]
	[4-5 Seconds]

## 3.6 Boot Settings

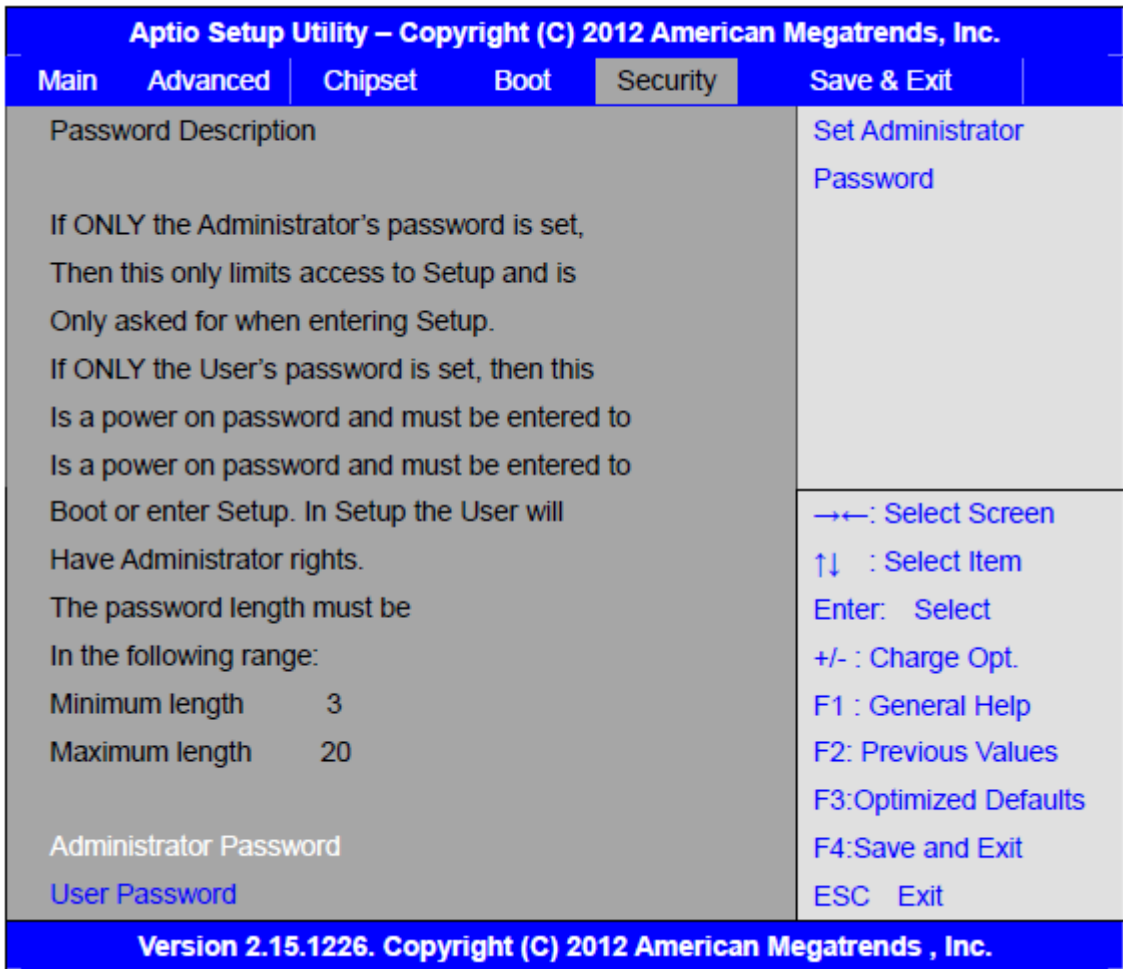
Aptio Setup Utility – Copyright (C) 2012 American Megatrends, Inc.					
Main	Advanced	Chipset	Boot	Security	Save & Exit
Boot Configuration				Number of seconds to Wait for setup	
Setup Prompt Timeout				1	
Bootup Numlock State				[On]	
Quiet Boot				[Disabled]	
Fast Boot				[Enabled]	
Skip USB				[Disabled]	
Skip PS2				[Disabled]	
CSM16 Module Version				07.69	
Gatea20 Active				[Upon Request]	
Option ROM Messages				[Force BIOS]	
Interrupt 19 Capture				[Immediate]	
Driver Option Priorities				→←: Select Screen	
Boot Option Priorities				↑↓ : Select Item	
Boot Option Priorities				Enter: Select	
Boot Option #1				+/- : Change Opt.	
Boot Option #2				F1 : General Help	
Hard Drive BBS Priorities				F2: Previous Values	
▶ CSM Parameters				F3:Optimized Defaults	
				F4:Save and Exit	
				ESC Exit	

Setup Prompt Timeout	[1]
Bootup Numlock State	[On]
Quiet Boot	[off]
Fast Boot	[Disabled]
Skip USB	[Enabled]
Skip PS2	[Enabled]
Skip VGA	[Disabled]

		[Enabled]
		[Disabled]
Skip USB		[Disabled]
		[Enabled]
Skip PS2		[Disabled]
		[Enabled]
CSM16 Module Version	07.69	
Gatea20 Active		[Upon Request]
		[Always]
Option ROM Messages		[Force BIOS]
		[Keep Current]
Interrupt 19 Capture		[Immediate]
		[Postponed]
Boot Option #1		
Boot Option #2		
.....		
Hard Drive BBS Priorities	Sets the system boot order [SATA PM:*** ... ] Boot Option #1 SATA PM:*** ... ***** Disabled	
CSM Parameters		
Launch CSM		[Always]
		[Never]
Boot option filter		[UEFI and Legacy]
		[Legacy only]
		[UEFI only]
Launch PXE OpROM poli		[Do not Launch]
		[UEFI only]
		[Legacy only]
Launch Storage OpROM		[Legacy only]

Launch Video OpROM po	[Do not Launch] [UEFI only]
Other PCI device ROM	[Legacy only] [Do not Launch] [UEFI only]  [UEFI OpROM] [Legacy OpROM]

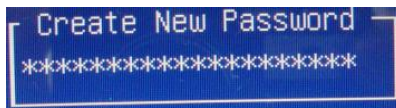
### 3.7 Security Settings



#### 3.7.1 Administrator Password



#### 3.7.2 User Password



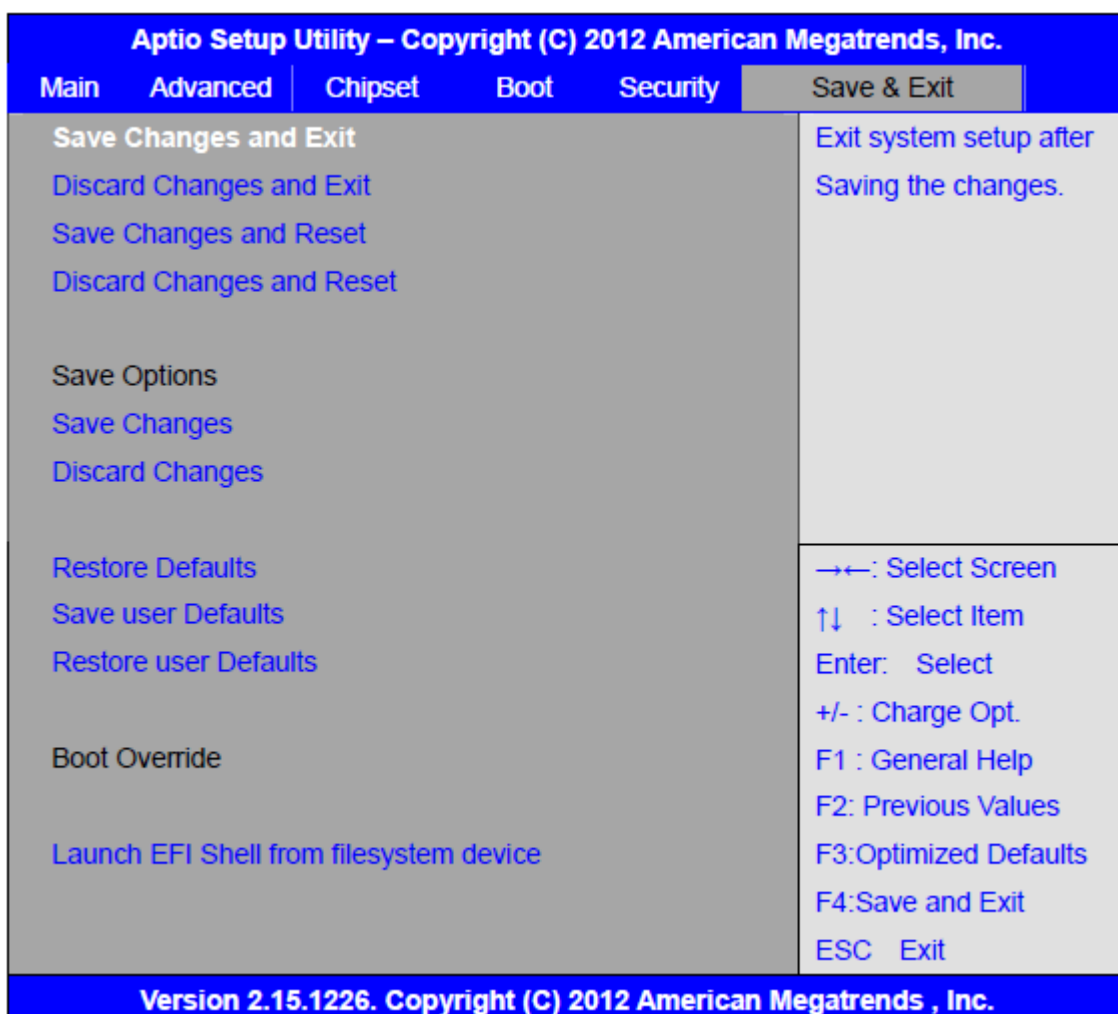
Type the password with up to 20 characters and then press <Enter> key. This will clear all previously typed CMOS passwords. You will be requested to confirm the password. Type the password again and press <Enter> key. You may press <Esc> key to abandon password entry operation.

To clear the password, just press <Enter> key when password input window pops up. A confirmation message will be shown on the screen as to whether the password will be disabled. You will have direct access to BIOS setup without typing any password after system reboot once the password is disabled.

Once the password feature is used, you will be requested to type the password each time you enter BIOS setup. This will prevent unauthorized persons from changing your system configurations.

Also, the feature is capable of requesting users to enter the password prior to system boot to control unauthorized access to your computer. Users may enable the feature in Security Option of Advanced BIOS Features. If Security Option is set to System, you will be requested to enter the password before system boot and when entering BIOS setup; if Security Option is set to Setup, you will be requested for password for entering BIOS setup.

### 3.8 Save & Exit Settings



Save Changes and Exit	
Save & Exit Setup save Configuration and exit ?	[Yes]
	[No]
Discard Changes and Ext	
Exit Without Saving Quit without saving?	[Yes]
	[No]
Save Changes and Reset	
Save & reset Save Configuration and reset?	[Yes]
	[No]
Discard Changes and Reset	
Reset Without Saving Reset without saving?	[Yes]
	[No]
Save Changes	
Save Setup Values Save configuration?	[Yes]
	[No]
Discard Changes	
Load Previous Values Load Previous Values?	[Yes]
	[No]
Restore Defaults	
Load Optimized Defaults Load optimized Defaults?	[Yes]
	[No]
Save user Defaults	
Save Values as User Defaults Save configuration?	[Yes]
	[No]
Restore user Defaults	
Restore User Defaults Restore User Defaults?	[Yes]
	[No]
Launch EFI Shell from filesystem device	
WARNING Not Found	[ok]

# Chapter 4 Installation of Drivers

This chapter describes the installation procedures for software and drivers under the windows 7. The software and drivers are included with the motherboard. The contents include **Intel chipset driver, VGA driver, LAN drivers, Audio driver** Installation instructions are given below.

## **Important Note:**

After installing your Windows operating system, you must install first the Intel Chipset Software Installation Utility before proceeding with the installation of drivers.



## 4.1 Intel Chipset Driver

To install the Intel chipset driver, please follow the steps below.

**Step 1.** Select **Intel (R) Chipset NM10 Express** from the list



**Step 2.** Click **Next** to setup program.





**Step 3.** Read the license agreement. Click **Yes** to accept all of the terms of the license agreement.



**Step 4.** Click **Next** to continue.



**Step 5. Click Next.**



**Step 6. Select Yes, I want to restart this computer now. Click Finish, then remove any installation media from the drives.**



## 4.2 Intel Graphics Media Accelerator Driver

To install the VGA drivers, follow the steps below to proceed with the installation.

**Step 1.** Select **Intel(R) VGA Chipset Driver**.

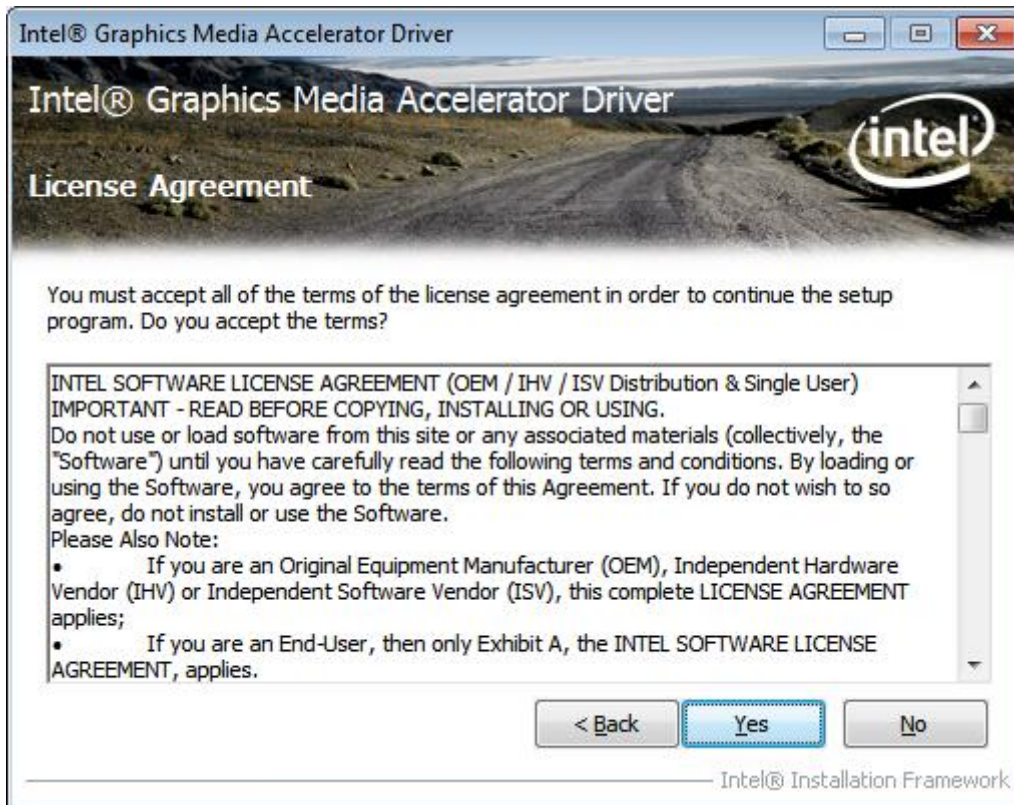


**Step 2.** Tick **Automatically run WinSAT and enable the Windows Aero desktop theme(if supported)**. Click **Next**.

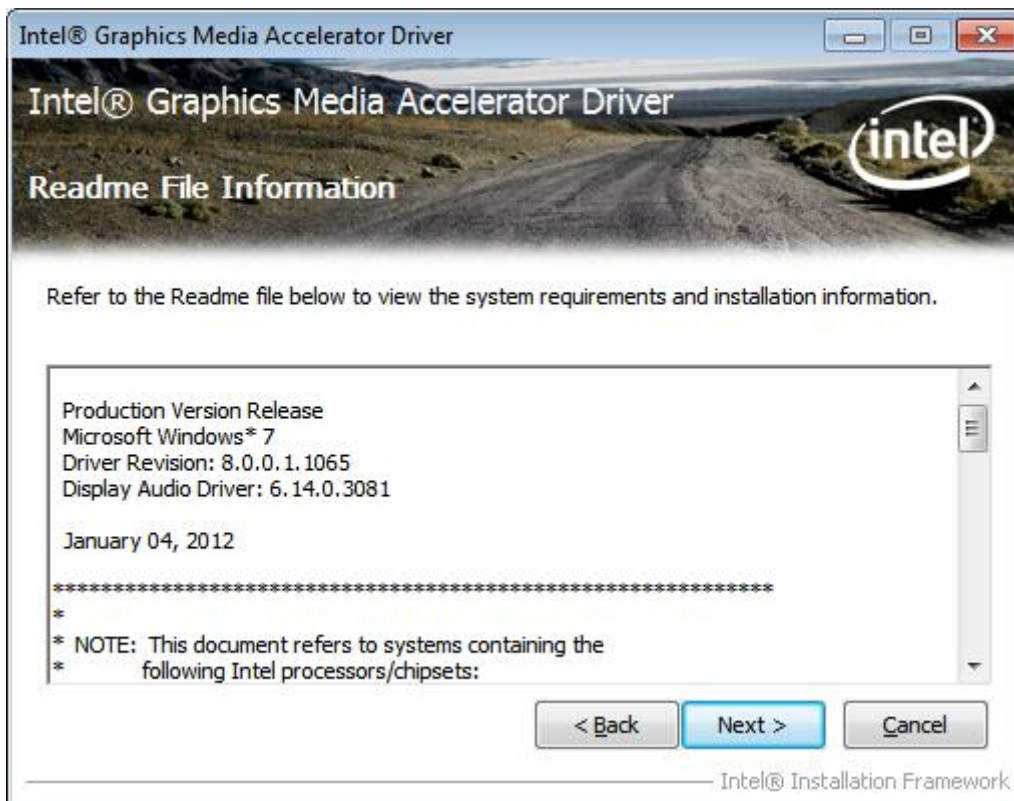




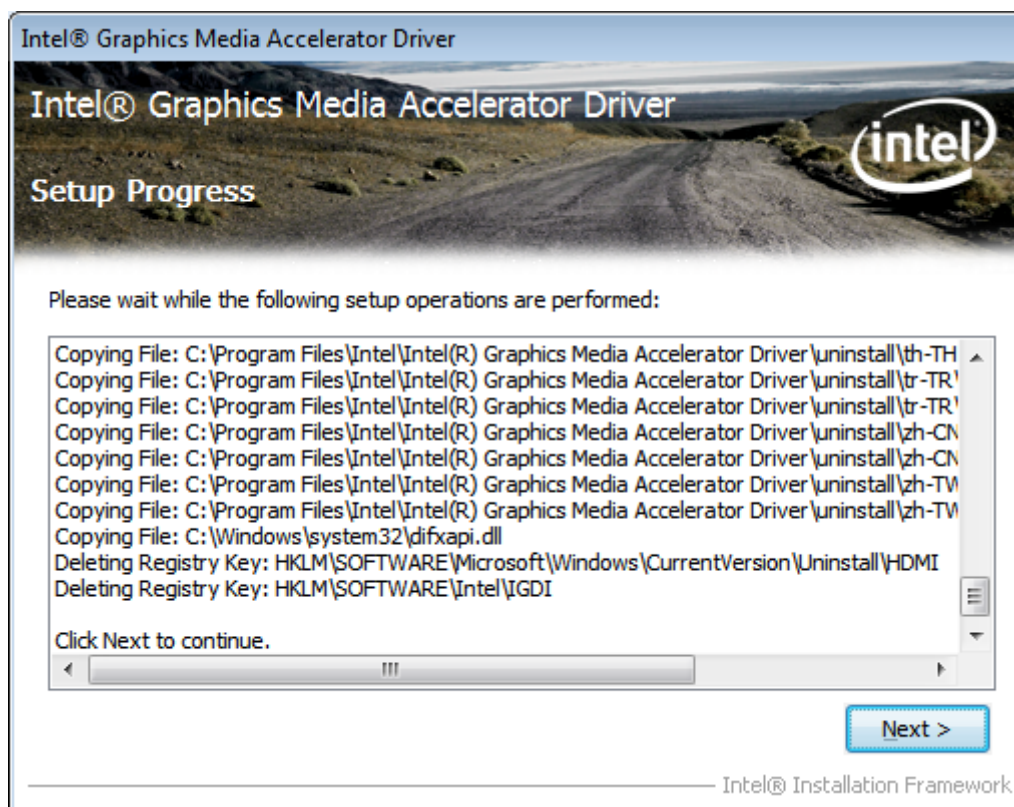
**Step 3.** Read license agreement. Click **Yes**.



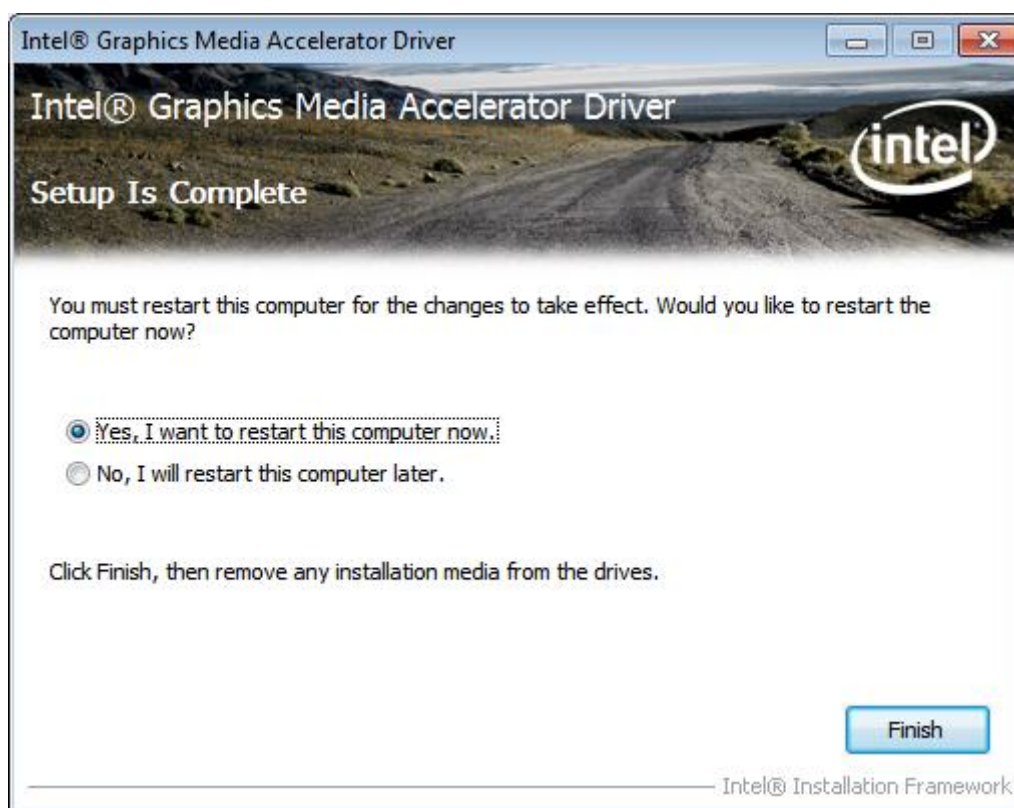
**Step 4.** Click **Next**.



**Step 5. Click Next.**



**Step 6. To restart the computer, select Yes, I want to restart this computer now. Then click Finish.**



## 4.3 Intel (R) Network Adapter

To install the Intel (R) Network Adapter device driver, please follow the steps below.

**Step 1. Select LAN Driver.**



**Step 2. Select 17"~19".**

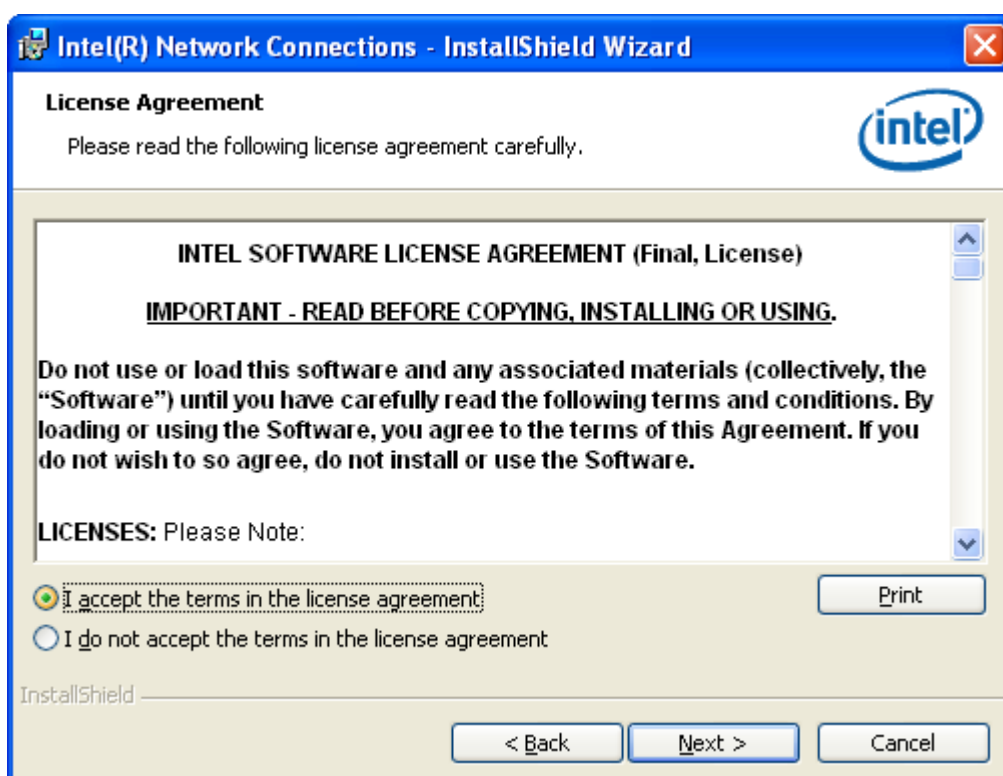




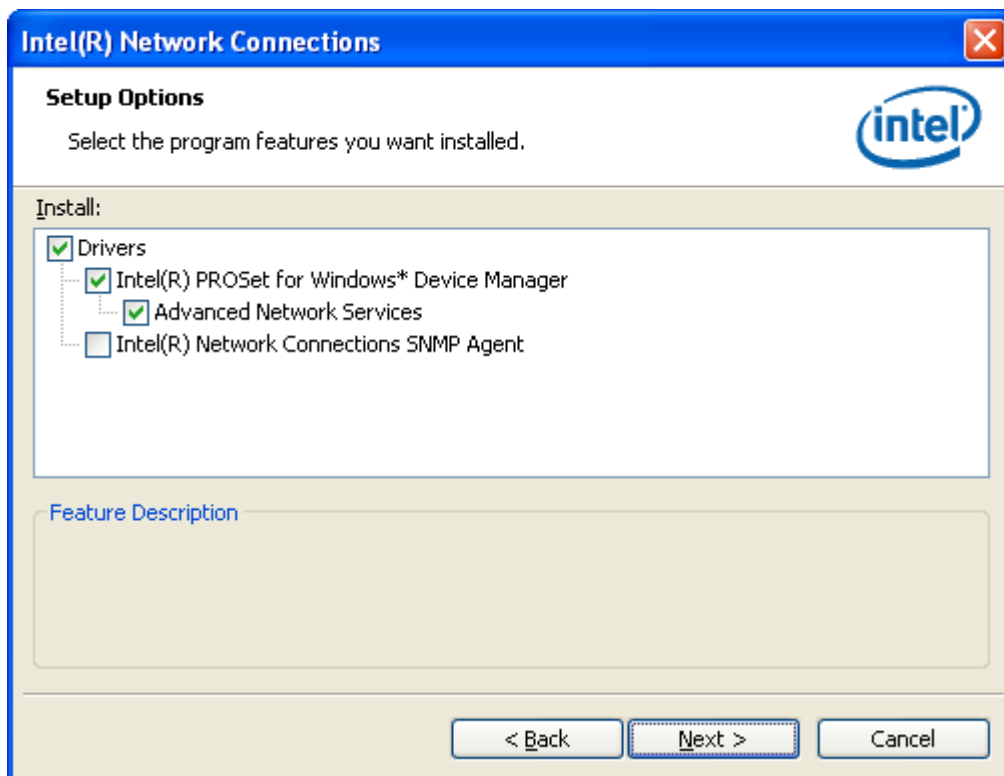
**Step 3.** Click **Next** to Continue.



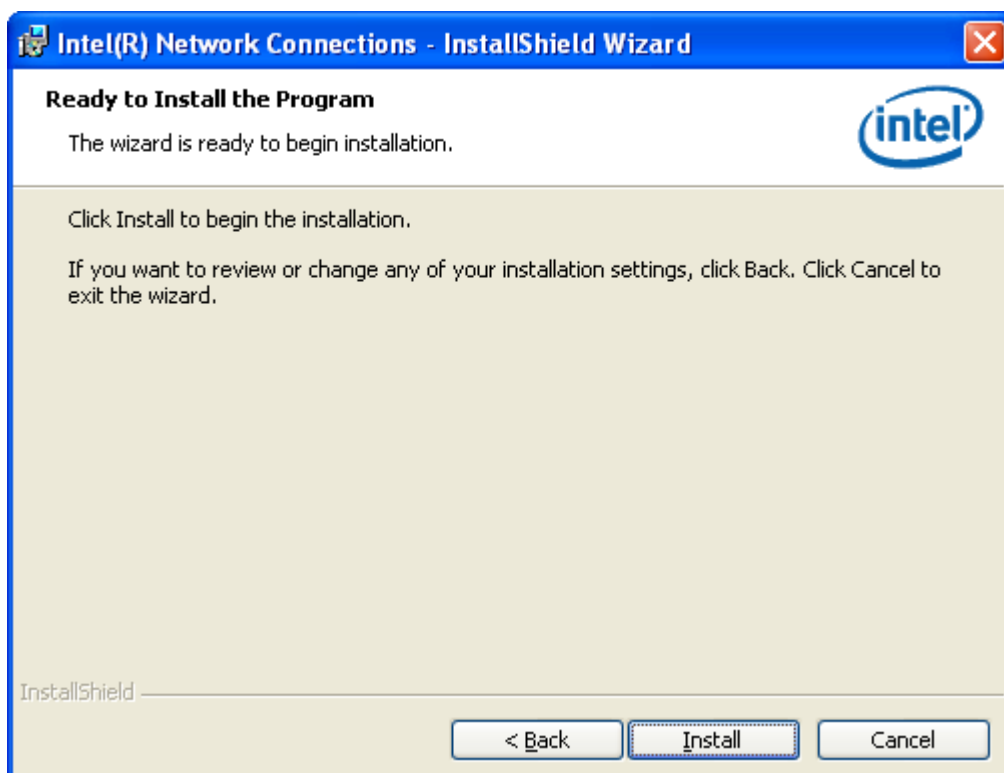
**Step 4.** Read license agreement. Click **I accept the terms in the license agreement**.  
Click **Next**



**Step 5.** Click **Advanced Network Services**. Then click **Next** to Continue.

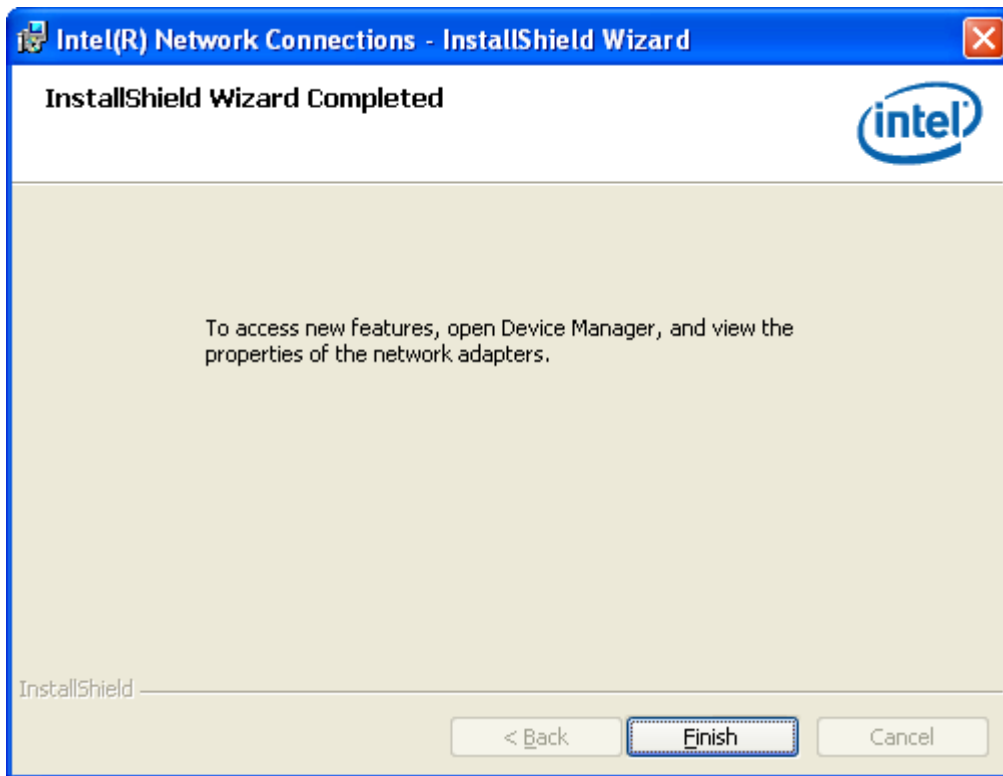


**Step 6.** Click **Install** to begin the installation.





**Step 7.** Click **Finish** to exit the wizard.



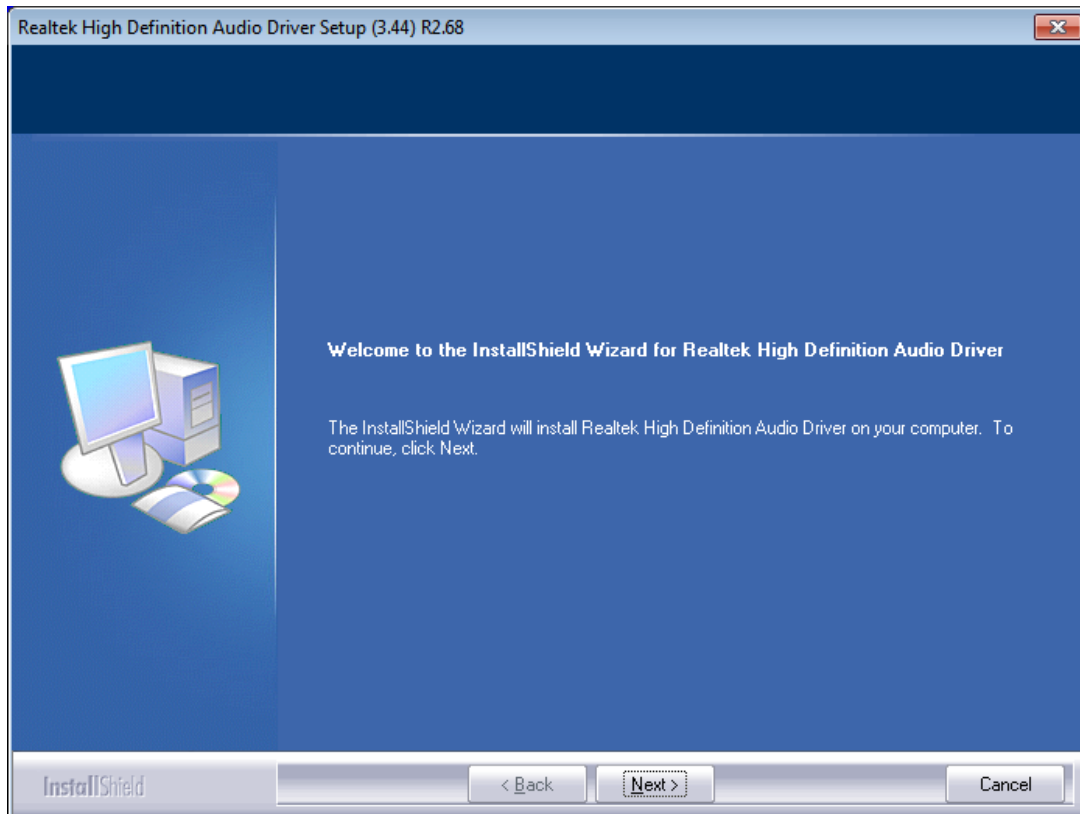
## 4.4 Realtek ALC662 HD Audio Codec Driver Installation

To install the Realtek ALC662 HD Audio Codec Driver, please follow the steps below.

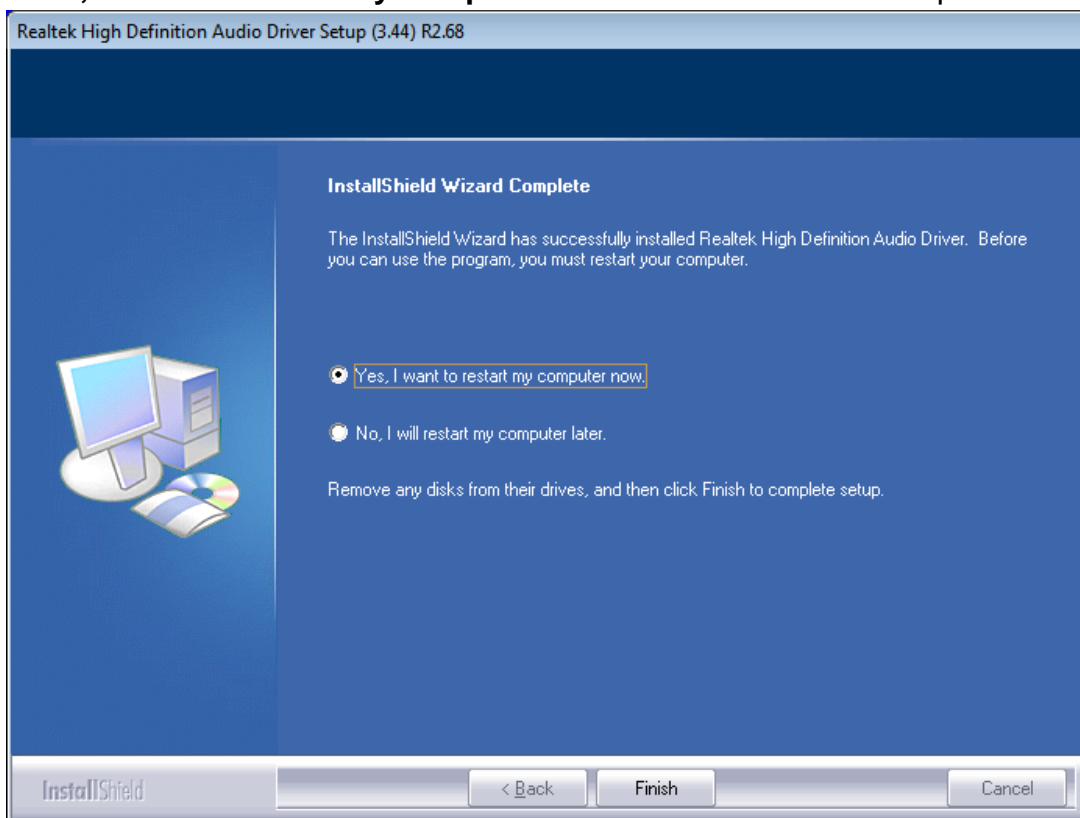
**Step 1.** Select **Realtek AL662 Audio Codec Driver** from the list



**Step 2.** Click **Next** to continue.



**Step 3.** Click **Yes, I want to restart my computer now.** Click **Finish** to complete the installation.



# Chapter 5 Touch Screen Installation

This chapter describes how to install drivers and other software that will allow your touch screen work with different operating systems.

## 5.1 Windows 2000/2003/Vista/WIN7 Universal Driver

### Installation for PenMount 6000 Series

Before installing the Windows 2000/WIN7 driver software, you must have the Windows 2000/WIN 7 system installed and running on your computer. You must also have one of the following PenMount 6000 series controller or control boards installed: PM6500, PM6300.

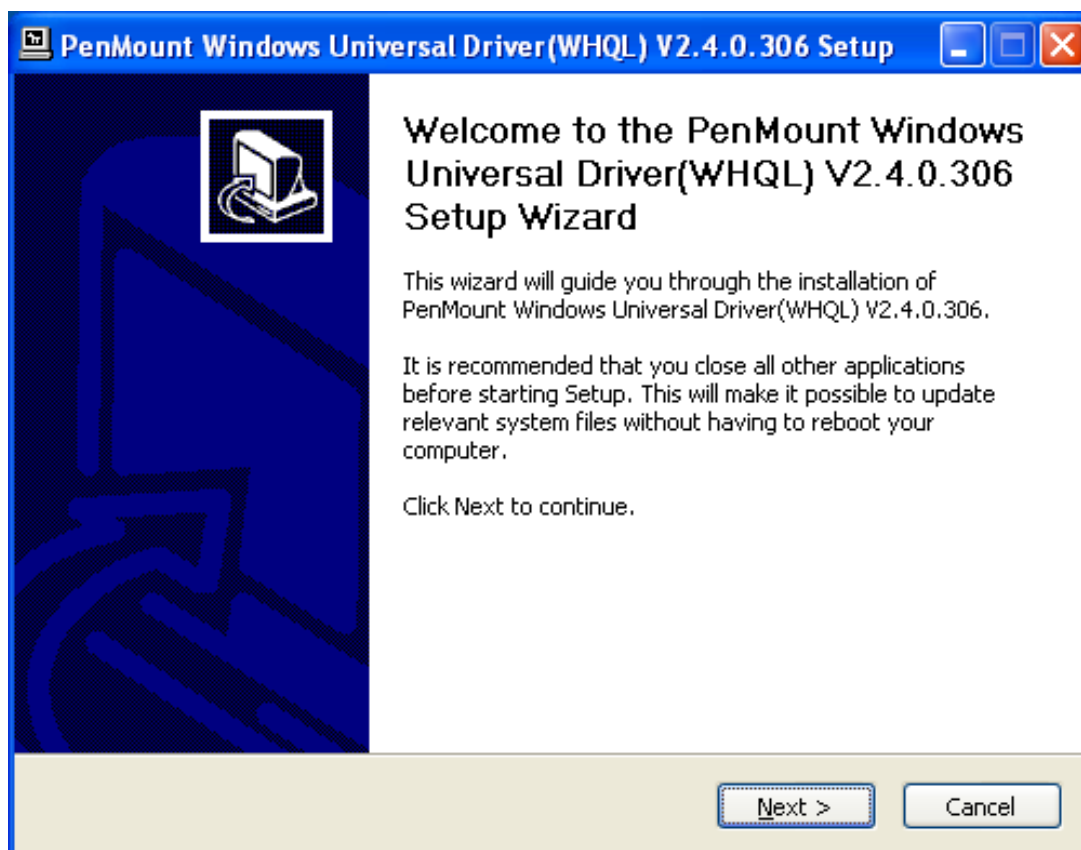
#### 5.1.1 Installing Software

If you have an older version of the PenMount Windows 2000/WIN7 driver installed in your system, please remove it first. Follow the steps below to install the PenMount DMC6000 Windows 2000/WIN7 driver.

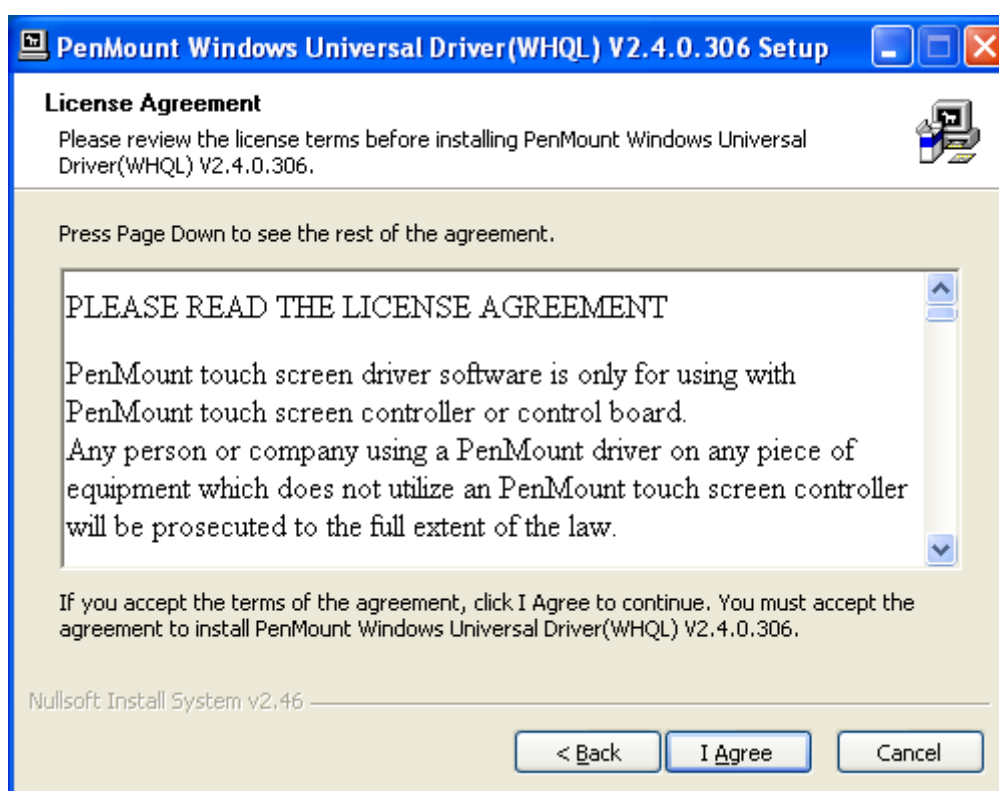
**Step 1.** Insert the product CD, the screen below would appear. Click touch panel driver.



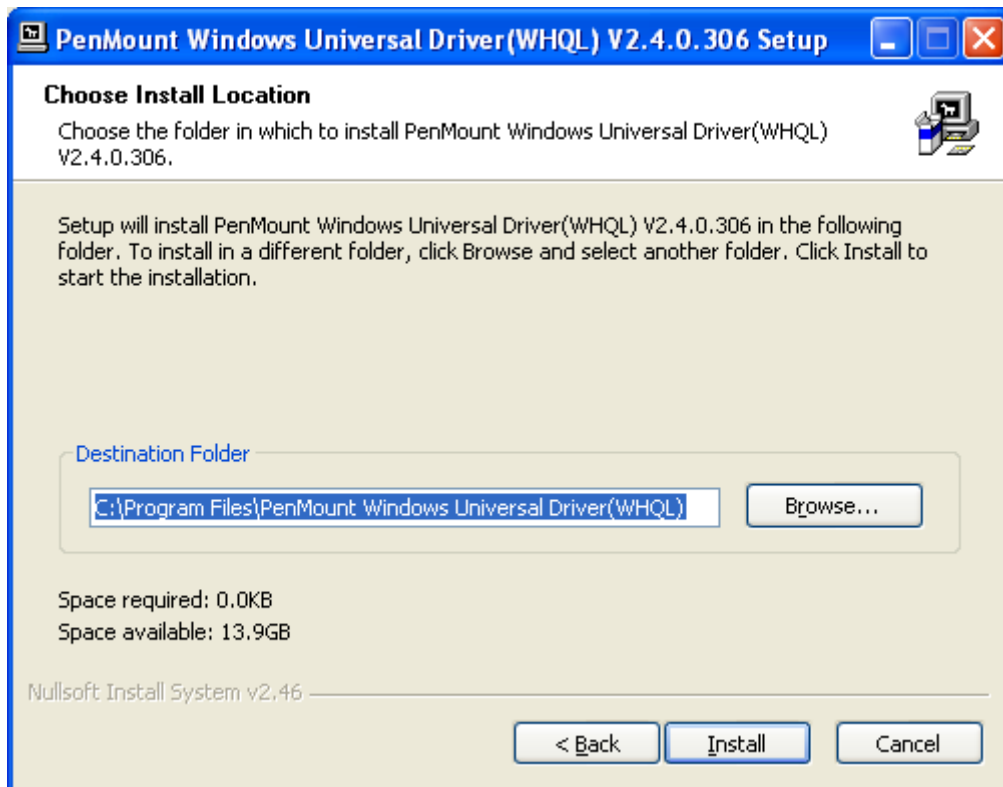
**Step 2.** Click **Next** to continue.



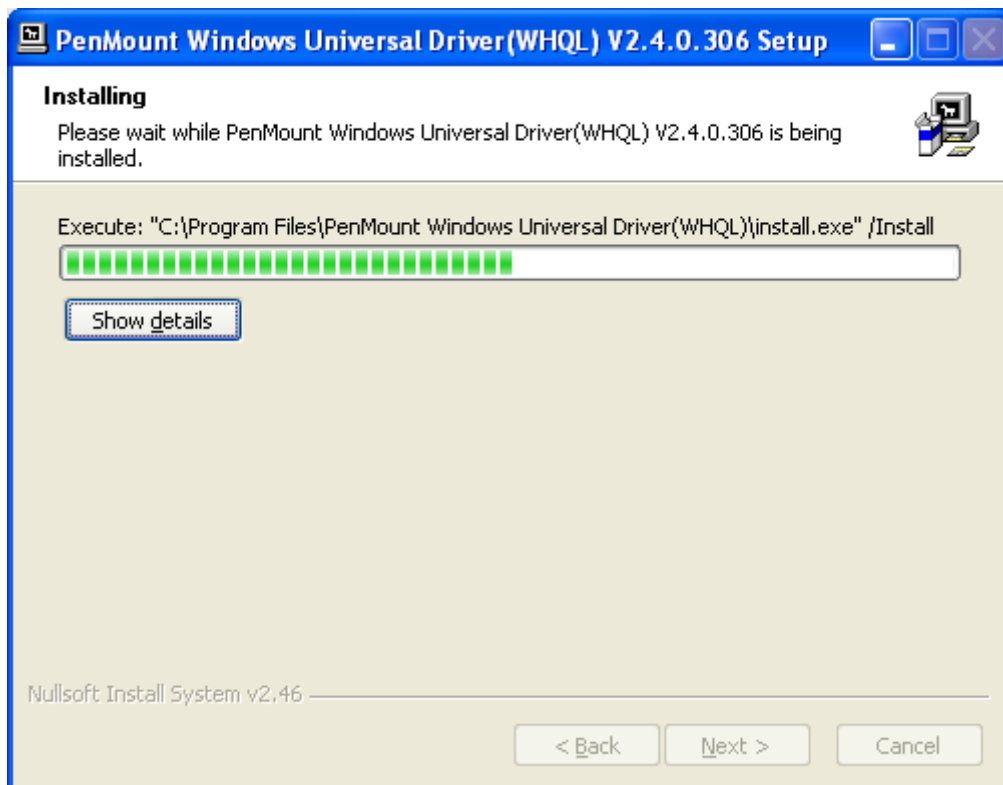
**Step 3.** Read the license agreement. Click **I Agree** to agree the license agreement.



**Step 4.** Choose the folder in which to install PenMount Windows Universal Driver. Click **Install** to start the installation.



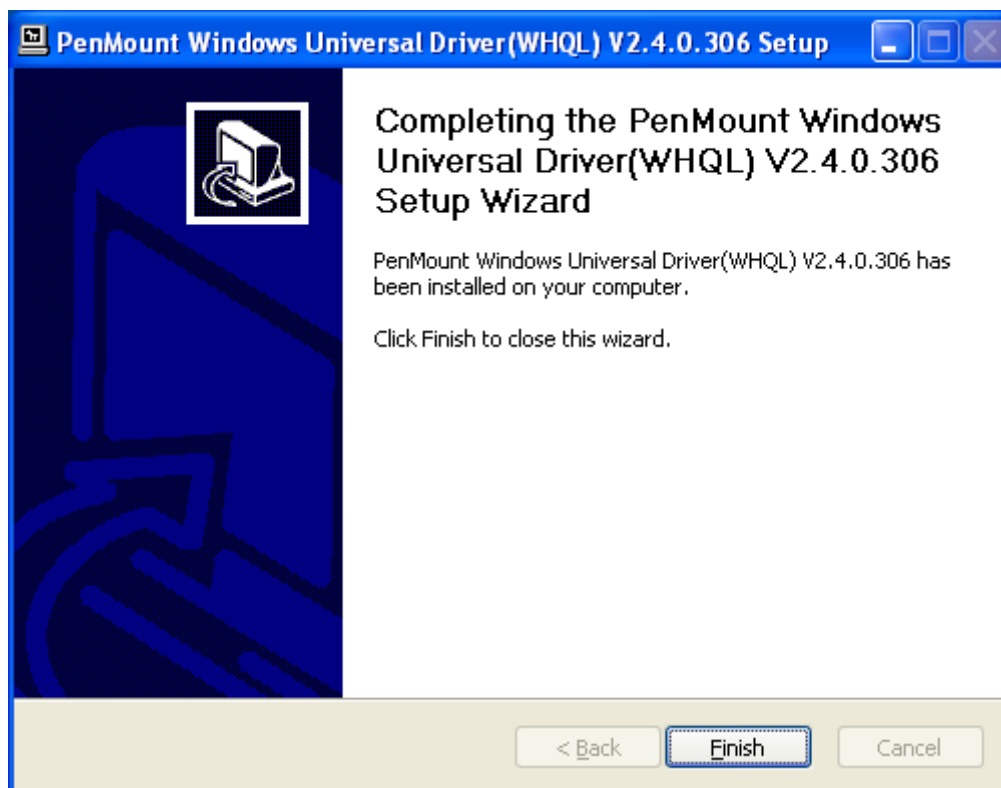
**Step 5.** Wait for installation. Then click **Next** to continue.



**Step 6. Click Continue Anyway.**



**Step 7. Click Finish** to complete installation.





## 5.2 Software Functions

Upon rebooting, the computer automatically finds the new 6000 controller board. The touch screen is connected but not calibrated. Follow the procedures below to carry out calibration.

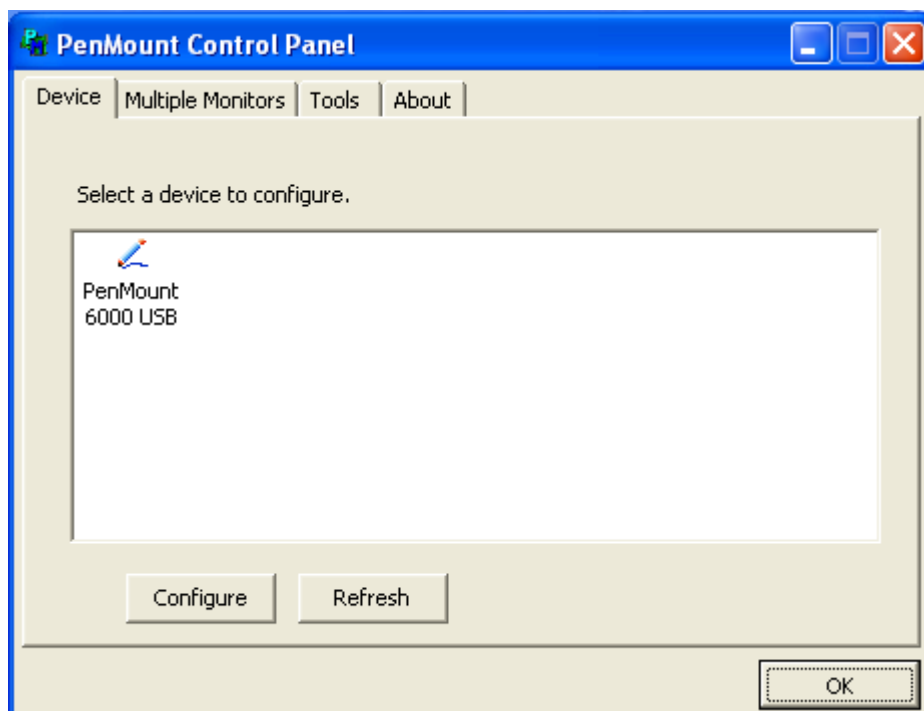
1. After installation, click the PenMount Monitor icon “PM” in the menu bar.
2. When the PenMount Control Panel appears, select a device to “Calibrate.”

### PenMount Control Panel

The functions of the PenMount Control Panel are **Device**, **Multiple Monitors**, **Tools** and **About**, which are explained in the following sections.

#### Device

In this window, you can find out that how many devices be detected on your system.



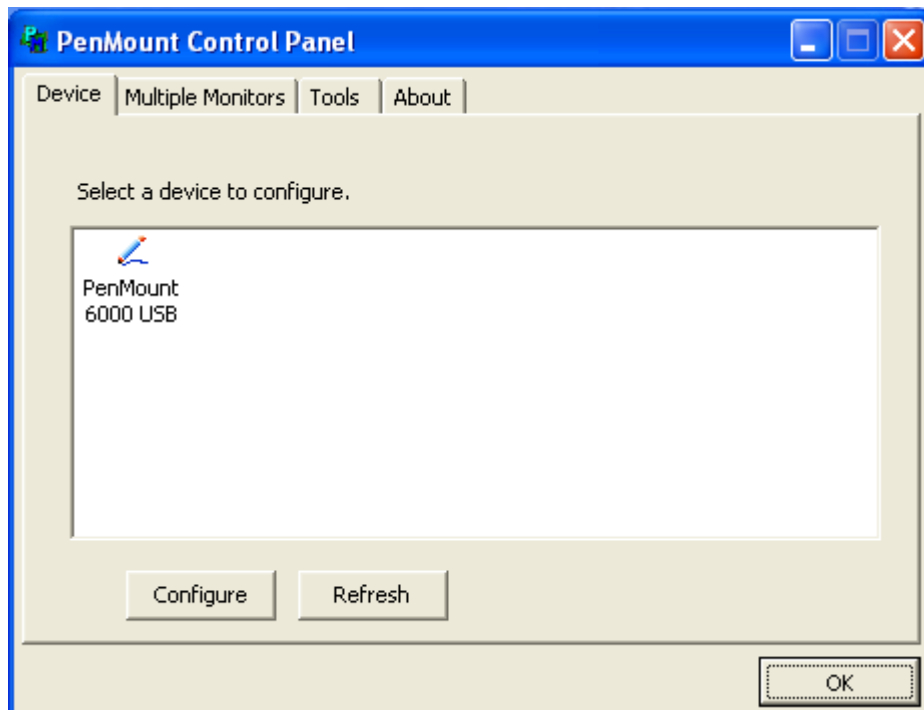
#### Calibrate

This function offers two ways to calibrate your touch screen. ‘Standard Calibration’ adjusts most touch screens. ‘Advanced Calibration’ adjusts aging touch screens.

Standard Calibration	<b>Click this button and arrows appear pointing to red squares. Use your finger or stylus to touch the red squares in sequence. After the fifth red point calibration is complete. To skip, press ‘ESC’.</b>
----------------------	--

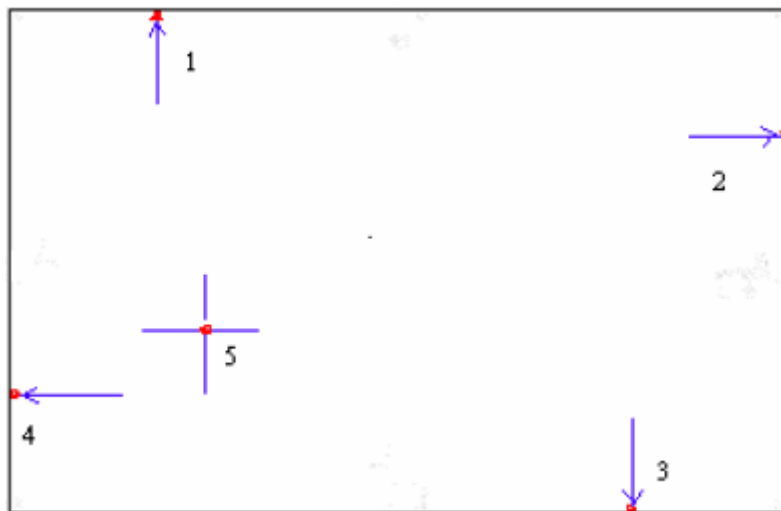
Advanced Calibration	<b>Advanced Calibration uses 4, 9, 16 or 25 points to effectively calibrate touch panel linearity of aged touch screens. Click this button and touch the red squares in sequence with a stylus. To skip, press ESC'.</b>
Command Calibration	<b>Command call calibration function. Use command mode call calibration function, this can uses Standard, 4, 9, 16 or 25 points to calibrate</b> E.g. Please run ms-dos prompt or command prompt c:\Program Files\PenMount Universa Driver\Dmcctrl.exe -calibration 0 ( Standard Calibration) Dmcctrl.exe - calibration (\$) 0= Standard Calibration 4=Advanced Calibration 9=Advanced Calibration 9 16=Advanced Calibration 16 25=Advanced Calibration 25

**Step 1.** Please select a device then click “Configure”. You can also double click the device too.



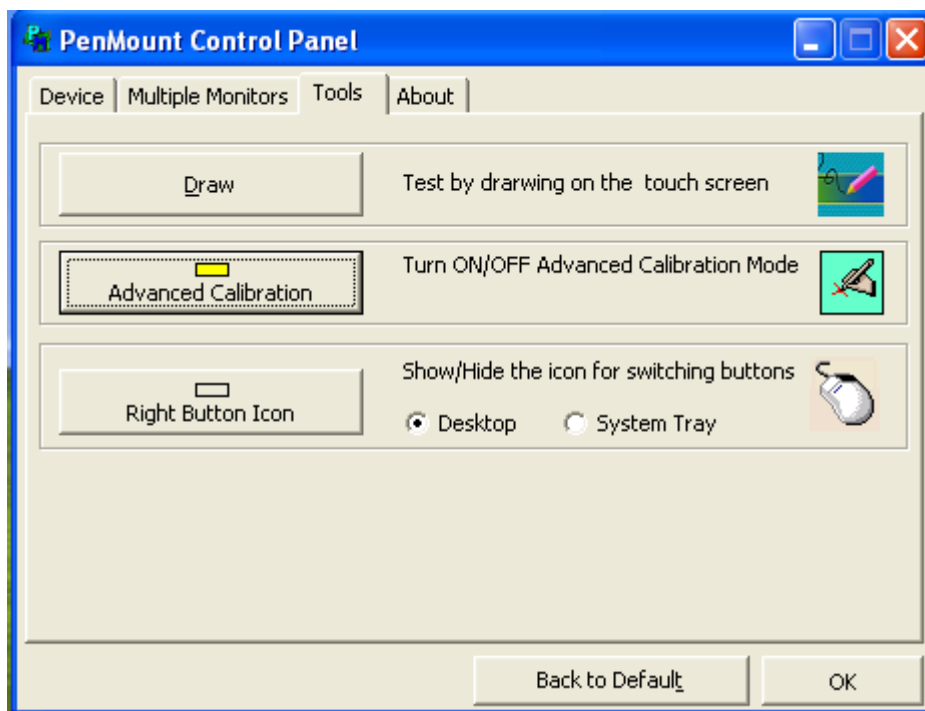


**Step 2.**Click “Standard Calibration” to start calibration procedure



**NOTE:** The older the touch screen, the more Advanced Mode calibration points you need for an accurate calibration. Use a stylus during Advanced Calibration for greater accuracy. Please follow the step as below:

**Step 3.** Come back to “PenMount Control Panel” and select **Tools** then click **Advanced Calibration**.



**Step 4.** Select **Device** to calibrate, then you can start to do **Advanced Calibration**.



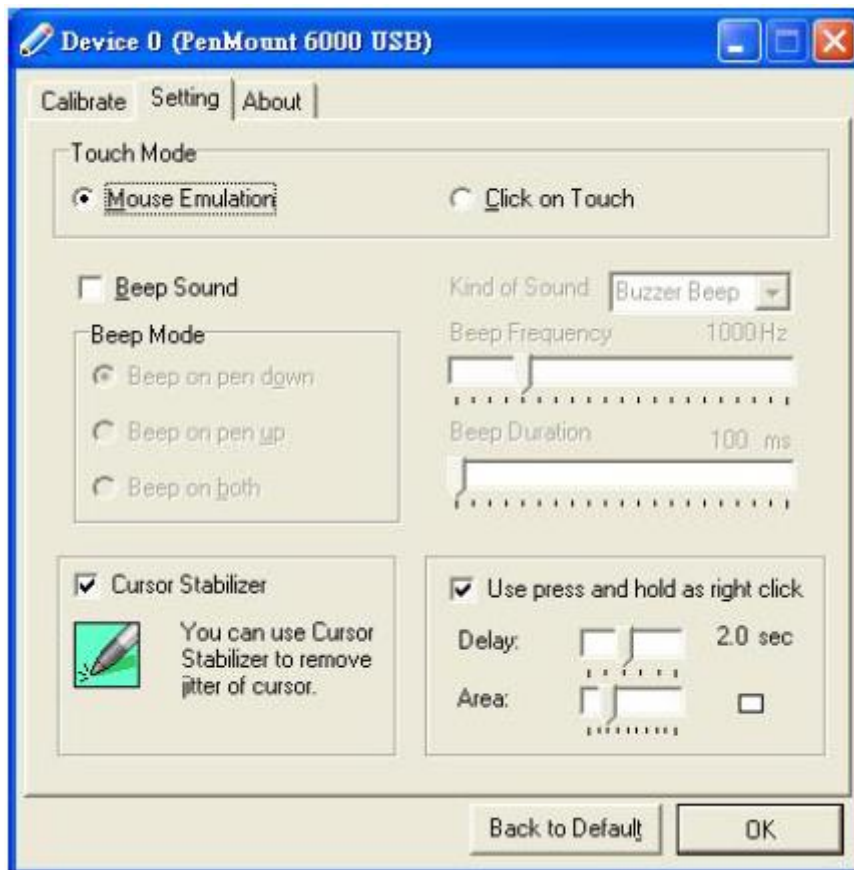
**NOTE:** Recommend to use a stylus during Advanced Calibration for greater accuracy.



Plot Calibration Data	Check this function and a touch panel linearity comparison graph appears when you have finished Advanced Calibration. The blue lines show linearity before calibration and black lines show linearity after calibration.
Turn off EEPROM storage	The function disable for calibration data to write in Controller. The default setting is Enable.

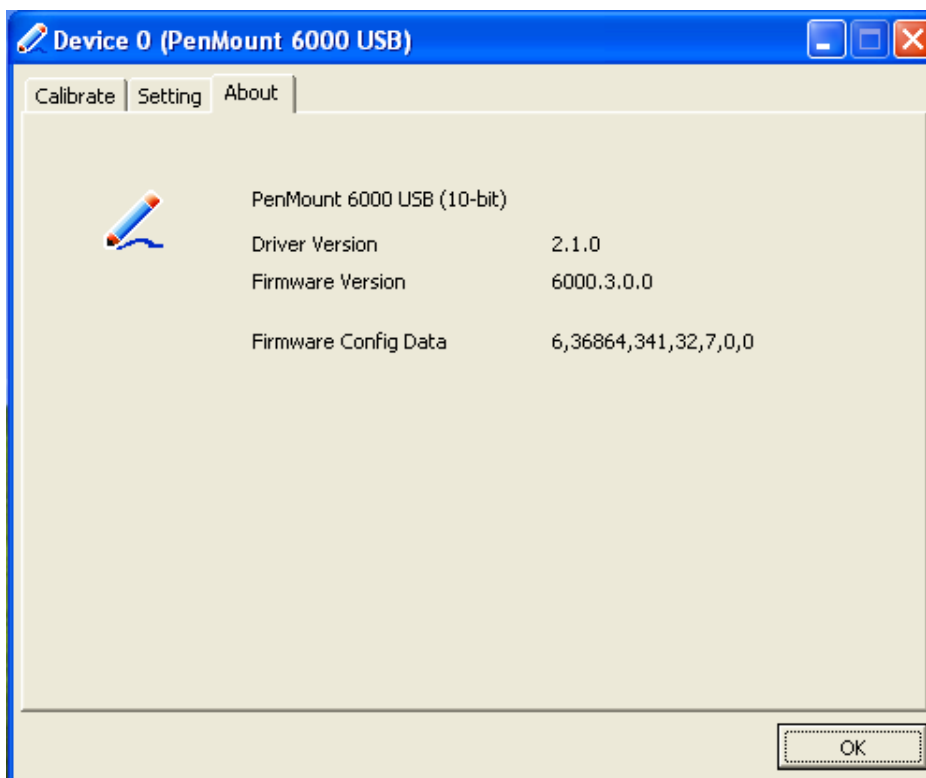
## Setting

Touch Mode	<p>This mode enables and disables the mouse's ability to drag on-screen icons – useful for configuring POS terminals.</p> <p><b>Mouse Emulation</b> – Select this mode and the mouse functions as normal and allows dragging of icons.</p> <p><b>Click on Touch</b> – Select this mode and mouse only provides a click function, and dragging is disables.</p>
Beep Sound	<p><b>Enable Beep Sound</b> – turns beep function on and off</p> <p><b>Beep on Pen Down</b> – beep occurs when pen comes down</p> <p><b>Beep on Pen Up</b> – beep occurs when pen is lifted up</p> <p><b>Beep on both</b> – beep occurs when comes down and lifted up</p> <p><b>Beep Frequency</b> – modifies sound frequency</p> <p><b>Beep Duration</b> – modifies sound duration</p>
Cursor Stabilizer	Enable the function support to prevent cursor shake.
Use press and hold as right click	You can set the time out and area for you need.



## About

This panel displays information about the PenMount controller and driver version.



## Multiple Monitors

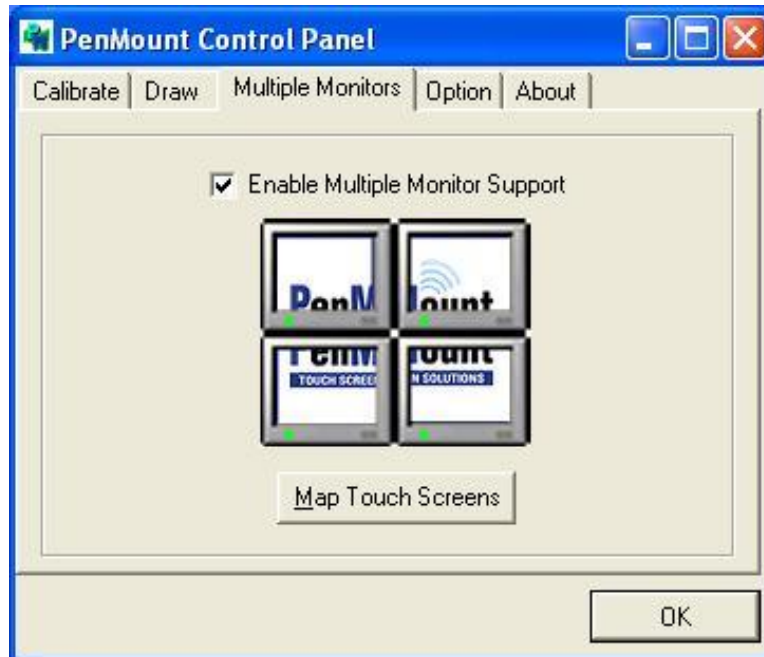
Multiple Monitors support from two to six touch screen displays for one system. The PenMount drivers for Windows 2000/WIN 7 support Multiple Monitors. This function supports from two to six touch screen displays for one system. Each monitor requires its own PenMount touch screen control board, either installed inside the display or in a central unit. The PenMount control boards must be connected to the computer COM ports via the RS-232 interface. Driver installation procedures are the same as for a single monitor. Multiple Monitors support the following modes:

Windows Extends Monitor Function  
Matrox DualHead Multi-Screen Function  
nVidia nView Function

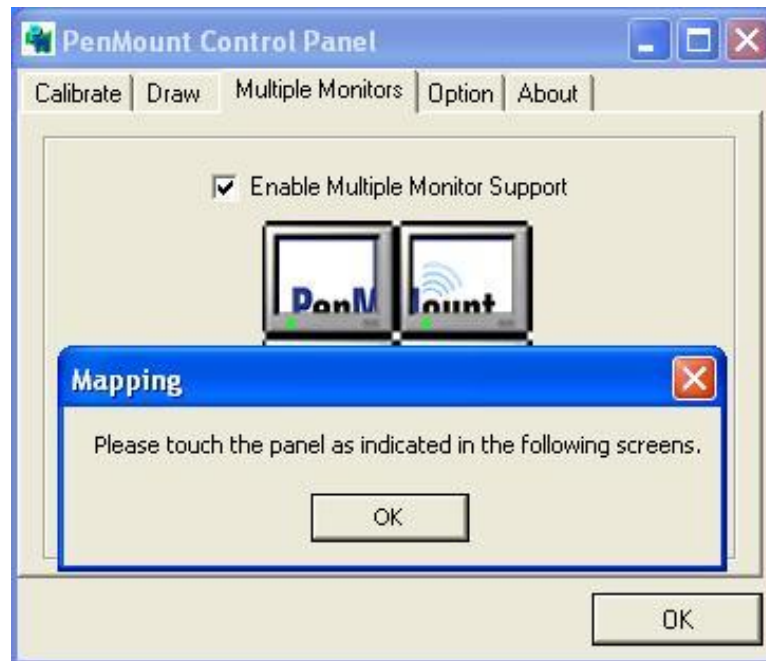
**NOTE:** The Multiple Monitor function is for use with multiple displays only. Do not use this function if you have only one touch screen display. Please note once you turn on this function the rotating function is disabled.

Enable the multiple display function as follows:

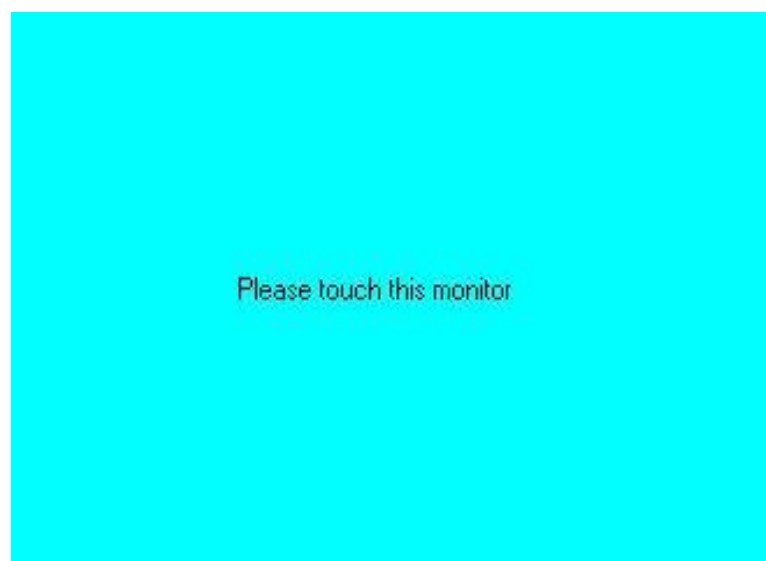
1. Check the **Enable Multiple Monitor Support** box; then click **Map Touch Screens** to assign touch controllers to displays.



- When the mapping screen message appears, click **OK**.



- Touch each screen as it displays “Please touch this monitor”. Following this sequence and touching each screen is called **mapping the touch screens**.



- Touching all screens completes the mapping and the desktop reappears on the monitors.
- Select a display and execute the “Calibration” function. A message to start calibration appears. Click **OK**.



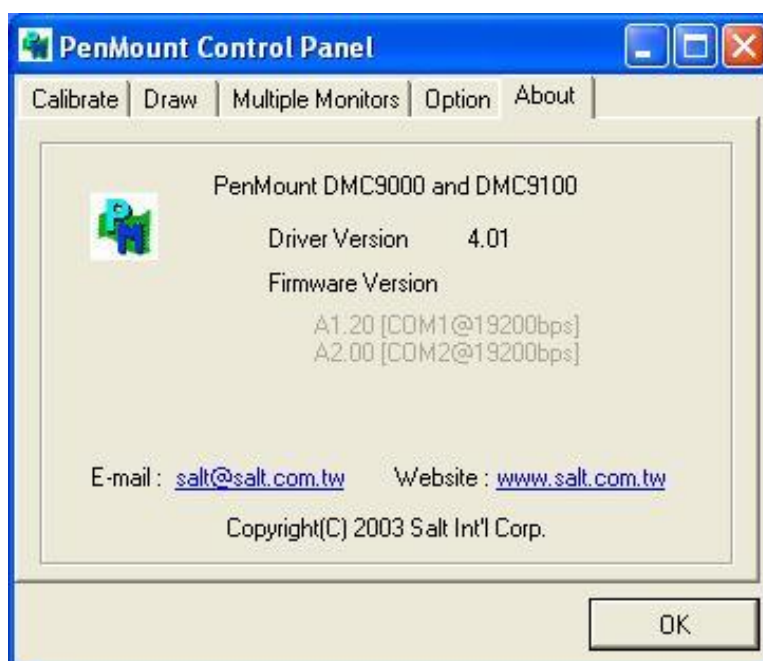
- “Touch this screen to start its calibration” appears on one of the screens. Touch the screen.

7. "Touch the red square" messages appear. Touch the red squares in sequence.
8. Continue calibration for each monitor by clicking **Standard Calibration** and touching the red squares.

- NOTES:**
1. If you use a single VGA output for multiple monitors, please do not use the **Multiple Monitor** function. Just follow the regular procedure for calibration on each of your desktop monitors.
  2. The Rotating function is disabled if you use the Multiple Monitor function.
  3. If you change the resolution of display or screen address, you have to redo **Map Touch Screens**, so the system understands where the displays are.

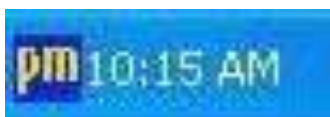
## About

This panel displays information about the PenMount controller and this driver version.

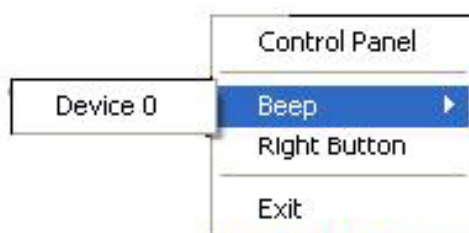



## PenMount Monitor Menu Icon

The PenMount monitor icon (PM) appears in the menu bar of Windows 2000/WIN7 system when you turn on PenMount Monitor in PenMount Utilities.



PenMount Monitor has the following function



Control Panel	<b>Open Control Panel Windows</b>
Beep	<b>Setting Beep function for each device</b>
Right Button	<b>When you select this function, a mouse icon appears in the right-bottom of the screen.</b> <b>Click this icon to switch between Right and Left Button functions.</b> 
Exit	<b>Exits the PenMount Monitor function.</b>

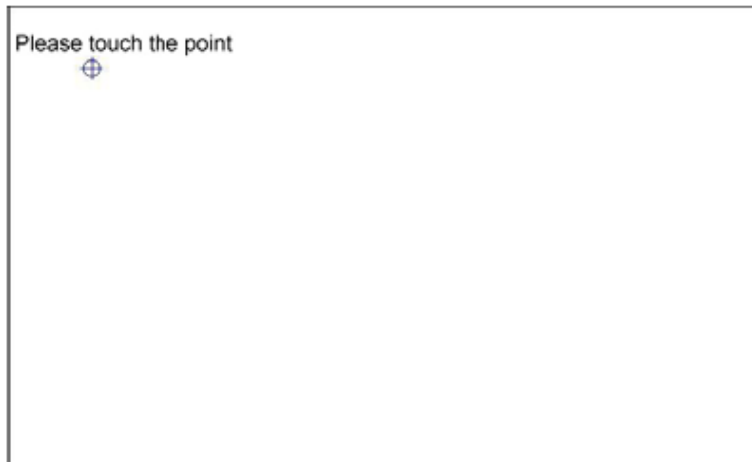
### PenMount Rotating Functions

The PenMount driver for Windows 2000/WIN7 supports several display rotating software packages. Windows Me/2000/WIN7 support display rotating software packages such as:

- Portrait's Pivot Screen Rotation Software
- ATI Display Driver Rotate Function
- nVidia Display Driver Rotate Function
- SMI Display Driver Rotate Function
- Intel 845G/GE Display Driver Rotate Function

### Configuring the Rotate Function

1. Install the rotation software package.
2. Choose the rotate function (0°, 90°, 180°, 270°) in the 3rd party software. The calibration screen appears automatically. Touch this point and rotation is mapped.



**NOTE:** The Rotate function is disabled if you use Monitor Mapping